



# CATALOGUE

IT - ES - FR

2026

# INDEX

	page
<b>1. POSTER FRAMES AND DISPLAYS</b> <i>Porta poster e Espositori</i> <i>Marcos para Póster y Expositores</i> <i>Cadres et présentoirs d'affiches</i>	14
1.1 Snap Frames <i>Cornici a scatto</i> <i>Marco para Póster</i> <i>Cadres Clic Clac</i>	18
1.2 Poster Frames <i>Porta poster</i> <i>Marco para Póster</i> <i>Cadres Poster</i>	26
1.3 Poster Displays <i>Espositori</i> <i>Porta Póster</i> <i>Panneaux d'Affichage</i>	30
1.4 Appendo Cable Systems <i>Porta poster con cavetti Appendo</i> <i>Sistemas de Cable Appendo</i> <i>Systèmes de Câblage Appendo</i>	37
<b>2. TEXTILE FRAMES</b> <i>Cornici per tessuto</i> <i>Marco Textil</i> <i>Cadres Textiles</i>	38
2.1 Textile Frames <i>Cornici per tessuto</i> <i>Marco Textil</i> <i>Cadres Textiles</i>	42
<b>3. ILLUMINATED DISPLAYS</b> <i>Espositori illuminati</i> <i>Tótems Publicitarios con Luz</i> <i>Displays Illuminés</i>	48
3.1 LED Poster Frames <i>Porta poster a LED</i> <i>Marcos para Póster LED</i> <i>Cadres LED pour Posters</i>	50
3.2 Lightboxes & Illuminated Totems <i>Cassonetti e totem luminosi</i> <i>Caja de luz y Tótems Luminosos</i> <i>Caissons et Totems Lumineux</i>	54
<b>4. DIGITAL DISPLAYS</b> <i>Espositori Digitali</i> <i>Pantallas Digitales</i> <i>Afficheurs Digitales</i>	62
4.1 Digital Displays <i>Espositori Digitali</i> <i>Pantallas Digitales</i> <i>Afficheurs Digitales</i>	66
4.2 Screen Holders and Tablet Holders <i>Supporti per schermi e tablet</i> <i>Soportes para Pantallas y Tablets</i> <i>Supports pour écrans et tablettes</i>	82

	page
<b>5. PAVEMENT SIGNS</b> <i>Espositori per marciapiedi</i> <i>Señales de Pavimento</i> <i>Chevalets de Trottoir</i>	86
5.1 A-Boards <i>Cavalletti</i> <i>Caballette Publicitario</i> <i>Stop-Trottoir</i>	88
5.2 Windtalkers <i>Windtalkers</i> <i>Paneles Involcables Exterior</i> <i>Stop-Trottoir</i>	102
<b>6. LEAFLET AND CATALOGUE HOLDERS</b> <i>Porta cataloghi e porta informazioni</i> <i>Portafolletos y Catálogos</i> <i>Porte-dépliants et Catalogues</i>	106
6.1 Leaflet and Catalogue Holders <i>Porta cataloghi e porta informazioni</i> <i>Portafolletos y Catálogos</i> <i>Porte-dépliants et Catalogues</i>	108
<b>7. WOODEN SIGNS</b> <i>Espositori in legno</i> <i>Carteles en Madera</i> <i>Panneaux en Bois</i>	114
7.1 Wooden Chalk A-Boards <i>Cavalletti in legno con lavagna</i> <i>Caballetes de Madera</i> <i>Stop-trottoirs en Bois pour Craie</i>	116
7.2 Wooden Chalk Boards <i>Cavalletti in legno con lavagna</i> <i>Pizarra de Sobremesa</i> <i>Dessus de Table en Bois</i>	121
7.3 Wooden Table Tops <i>Porta informazioni da tavolo in legno</i> <i>Pizarra de Sobremesa</i> <i>Dessus de Table en Bois</i>	125
<b>8. MENU DISPLAYS</b> <i>Porta Menu</i> <i>Porta Menú</i> <i>Affichages de Menu</i>	128
8.1 Menu Displays <i>Espositori per menu</i> <i>Porta Menú</i> <i>Affichages de Menu</i>	130
8.2 Menu Table Tops <i>Portamenù da tavolo</i> <i>Porta Menú de Mesa</i> <i>Présentoirs de Menus pour Tables</i>	140
<b>9. OUTDOOR EQUIPMENT</b> <i>Prodotti per uso esterno</i> <i>Equipamiento para Exterior</i> <i>Équipement Extérieur</i>	146
9.1 Outdoor Equipment <i>Prodotti per uso esterno</i> <i>Equipamiento para Exterior</i> <i>Équipement Extérieur</i>	148

	page
<b>10. LOCKABLE NOTICE BOARDS</b> <i>Bacheche con serratura</i> <i>Tablones de anuncios con cerradura</i> <i>Tableaux d'affichage verrouillables</i>	154
10.1 Indoor Lockable Notice Boards <i>Bacheche con serratura da interno</i> <i>Tablones de anuncios de interior con cerradura</i> <i>Tableaux d'affichage intérieurs avec système de verrouillage</i>	158
10.2 Outdoor Lockable Notice Boards <i>Bacheche con serratura da esterno</i> <i>Tablones de anuncios de exterior con cerradura</i> <i>Tableaux d'affichage extérieurs avec système de verrouillage</i>	164
<b>11. FLIPCHARTS AND WRITABLE BOARDS</b> <i>Flipcharts e lavagne riscrivibili</i> <i>Flipcharts y Pizarras</i> <i>Tableaux à feuilles mobiles et tableaux inscriptibles</i>	170
11.1 Flipcharts <i>Flipcharts</i> <i>Flipcharts</i> <i>Tableaux à feuilles mobiles</i>	172
11.2 Whiteboards and Pin Boards <i>Lavagne riscrivibili e per puntine</i> <i>Pizarras Blancas y Tableros de Anuncios</i> <i>Tableaux Blancs et Tableaux d'Affichage</i>	174
11.3 Accessories <i>Accessori</i> <i>Accesorios</i> <i>Accessoires</i>	176
<b>13. WAYFINDING SYSTEMS</b> <i>Sistemi di orientamento</i> <i>Sistemas de Orientación</i> <i>Systèmes d'orientation</i>	178
12.1 Wayfinding Systems <i>Sistemi di orientamento</i> <i>Sistemas de Orientación</i> <i>Systèmes d'Orientation</i>	180
12.2 Barriers <i>Barriere</i> <i>Barreras</i> <i>Barrières</i>	188
<b>12. GLASS SHOWCASES</b> <i>Bacheche di vetro</i> <i>Vitrinas en Vidrio</i> <i>Vitrines en Verre</i>	192
13.1 Glass Showcases <i>Bacheche di vetro</i> <i>Vitrinas en Vidrio</i> <i>Vitrines en Verre</i>	194
<b>14. BROCHURE HOLDERS</b> <i>Porta documenti</i> <i>Portafolletos</i> <i>Porte-brochures</i>	196

## LEGEND

	Writable surface		Graphic with zipper
	For indoor use		Graphic with Velcro
	For covered outdoor use		SEG Silicone Edge Graphic
	For outdoor use		1-foot banner
	For double-sided use		2-feet banner
	For single-sided use		No feet banner
	Connectable		Height adjustable
	Backlit illuminated		For landscape placement
	Lights as option		For portrait placement
	Including trolley		B1 certificate
	Including carrying bag		WiFi connection
	This product is lockable		USB slot
	IP56 resistance*		Other colours on request
	IP54 resistance*		Other sizes on request
	IP53 resistance*		Conformité Européenne
	UHD Ultra High Definition (4K) Screen		FHD Full High Definition Screen
	Plug & Play		+50°/-30° C
	20° Angle		30° Angle
	Touch function		Samsung VXT CMS
	Bluetooth		Including Wheels
	2 Years Warranty		Samsung Screen
	Tempered Glass		Delivered on a Pallet

\* IP53 is protected from limited dust ingress and water spray less than 60 degrees from vertical  
 \* IP54 is protected from limited dust ingress and water spray from any direction  
 \* IP56 is protected from limited dust ingress and from high pressure water jets from any direction

# INDEX

	page		page
14.1 Scritto® Brochure Holders <i>Porta documenti Scritto® Scritto® Portafolletos Scritto® Porte-brochures</i>	198	16.2 Outdoor Flags <i>Bandiere da esterno Banderas para Exterior Drapeaux d'extérieur</i>	240
14.2 Taymar® Brochure Holders <i>Porta documenti Taymar® Taymar® Portafolletos Taymar® Porte-brochures</i>	199	16.3 Accessories <i>Accessori Accesorios Accessoires</i>	246
14.3 Business Card Holders <i>Porta biglietti da visita Portafolletos Tarjetas de Visita Porte-cartes de Visite</i>	201	<b>17. COUNTERS AND TABLE COVERS</b> <i>Banchetti e tovaglie Mostradores y Cubiertas de Mesa Comptoirs et Housses de Table</i>	248
14.4 Outdoor Leaflet Holders <i>Porta biglietti da visita per uso esterno Portafolletos para Exteriores Porte-brochures pour Extérieur</i>	202	17.1 Counters and Accessories <i>Banchetti e accessori Mostradores y Accesorios Comptoirs et Accessoires</i>	250
14.5 Name Badges and Brochure Holder Magnetic <i>Portanomi e portadocumenti magnetici Porta Nombres y Portafolletos Magnético Badges Nominatifs et Porte-brochures Magnétique</i>	203	17.2 Table Covers <i>Tovaglie Cubiertas de Mesa Housses de Table</i>	264
<b>15. PORTA BANNERS</b> <i>Porta banners Banners Banners</i>	206	<b>18. WALLS</b> <i>Pareti Paneles Promocionales Murs</i>	266
15.1 Roll-Banners <i>Roll-Banners Roll-Banners Roll-Banners</i>	208	18.1 Lightboxes <i>Cassonetti Cajas de luz Caissons lumineux</i>	268
15.2 Bannerstands <i>Porta banners Banner Supports pour Bannières</i>	218	18.2 Pop-Ups <i>Pop-Ups Pop-Ups Stands Parapluie</i>	272
15.3 Hanging Banners <i>Porta banners a sospensione Banners Colgantes Banners Suspendues</i>	230	18.3 Zipper-Walls <i>Zipper-Walls Otras Paneles Autres Murs</i>	278
15.4 Accessories <i>Accessori Accesorios Accessoires</i>	232	18.4 Other Walls <i>Altre pareti Andere Wände Overige Wanden</i>	282
<b>16. FLAGS</b> <i>Bandiere Banderas Drapeaux</i>	234	<b>19. TENTS, UMBRELLAS AND SEATS</b> <i>Gazebo, ombrelloni e sedie Carpas, parasoles y asientos Tentes, parasols et sièges</i>	288
16.1 Indoor Flags <i>Bandiere da interno Banderas para Interior Drapeaux intérieur</i>	236	19.1 Tents and Accessories <i>Tende e accessori Carpas y accesorios Tentes et accessoires</i>	290
		19.2 Umbrellas and Accessories <i>Ombrelloni e accessori Parasoles y accesorios Parasols et accessoires</i>	294
		19.3 Beach Chairs and Cubes <i>Sedie a sdraio e cubi promozionali Sillas de playa y cubos Chillennes et cubes</i>	298



## POINT OF SALE

P. 12



## HOSPITALITY

P. 112



## OFFICE

P. 152



## PROMOTIONS AND EVENTS

P. 204

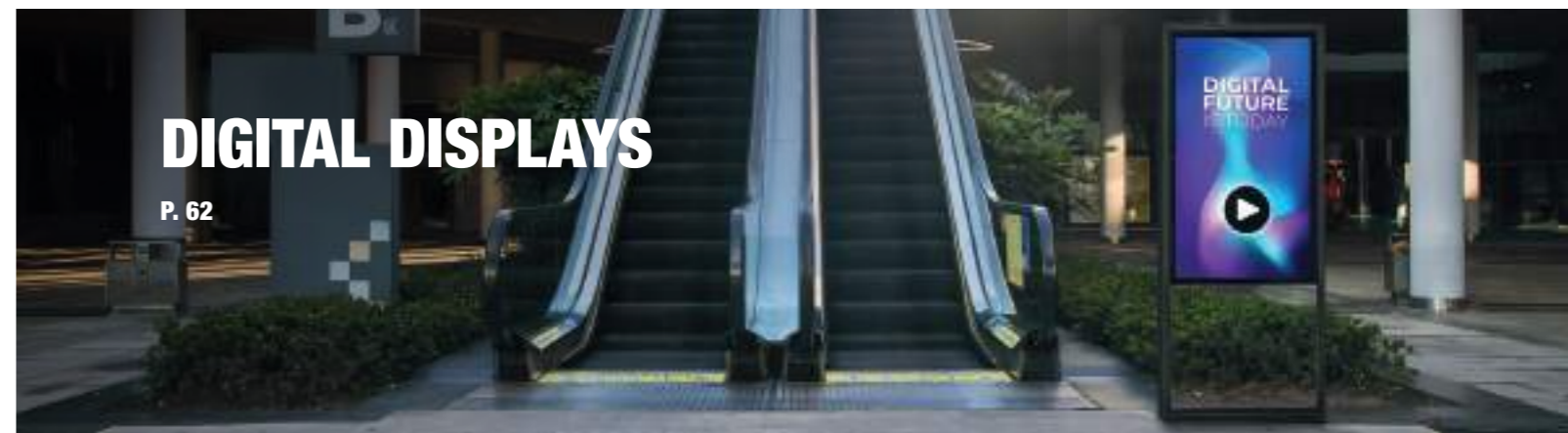

## DIGITAL DISPLAYS

P. 62

**NEW: BLACK COLOUR**



**BRIGHTBOX PRO FLEX WALL**  
See 3. Illuminated Displays  
page 58 or 18. Walls  
page 258



**DIGITAL SLIM TOTEM**  
See 4. Digital Displays  
page 70

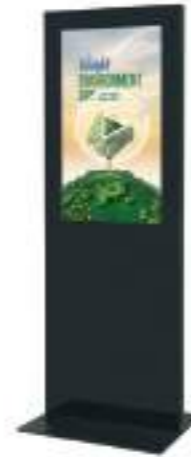

**DIGITAL COUNTERTOP NOVA**  
See 4. Digital Displays  
page 75



**SMART LINE DIGITAL  
A-BOARD TROLLEY CASE**  
See 4. Digital Displays  
page 81



**A-BOARD ELEGANT STEEL  
WITH LOGO PANEL**  
See 5. Pavement Signs  
page 95



**CITY SIGN ELEGANT  
STEEL**  
See 5. Pavement Signs  
page 97



**A-BOARD SLIDE IN**  
See 5. Pavement Signs  
page 96



**A-BOARD GRAB & GRIP**  
See 5. Pavement Signs  
page 98



**A-BOARD GRAB & GRIP BLACK**  
See 5. Pavement Signs  
page 98

**FENCE BARRIER GRAPHIC**  
See 12. Wayfinding Systems  
page 190



**HORECA UMBRELLA SLIDE**  
See 19. Tents, Umbrellas  
and Seats  
page 295

**BEACH CHAIR RELAX  
COMFORT**  
See 19. Tents, Umbrellas  
and Seats  
page 298



**BEACH CHAIR RELAX  
CLASSIC**  
See 19. Tents, Umbrellas  
and Seats  
page 298



**BEACH CHAIR RELAX DUO**  
See 19. Tents, Umbrellas  
and Seats  
page 299

**TABLE COVER STANDING ROUND  
BLACK AND WHITE**  
See 17. Counters and Table  
Covers  
page 264



**FLAG POLE CLASSIC  
GRAPHIC**  
See 16. Flags  
page 245



**BEACH CHAIR RELAX BOLD**  
See 19. Tents, Umbrellas  
and Seats  
page 299



**CUBE SEAT FOLD**  
See 19. Tents, Umbrellas  
and Seats  
page 300



**CUBE SEAT CLASSIC**  
See 19. Tents, Umbrellas  
and Seats  
page 300

**NEW: ECO VERSION**



**COUNTER PROFESSIONAL  
ORIGINAL M**  
See 17. Counters and Table  
Covers  
page 258



**PERSONALISED HIPS  
BOARD GRAPHICS**  
See 3. Illuminated Displays  
page 61

**NEW: ECO VERSION**



**WATER BAG**  
See 16. Flags  
page 247

**NEW: ECO VERSION**

# HIGHLIGHTED

## DIGITAL COUNTERTOP NOVA

NEW

Share your message in a modern, dynamic way with the Digital Countertop Nova! Featuring a vibrant 13" Samsung UHD screen, this compact L-shaped display provides stunning visuals without taking over your counter. Its fingerprint-resistant paint finish keeps it looking clean and professional with minimal upkeep. Perfect for reception desks, retail counters, and service areas. Delivered fully assembled and ready to use right out of the box. Plug&play your content 24/7 via USB, or upgrade to the full experience with Samsung VXT CMS!

page 75



## CITY SIGN ELEGANT STEEL

NEW

Boost your street presence with the City Sign Elegant Steel. Its circular steel base ensures sidewalk safety, while the powder-coated frame withstands all weather conditions. Display your messages on both sides and highlight your branding at the rounded top. Durable, stylish, and perfect for urban environments!

page 97

### A-BOARD GRAB & GRIP BLACK

NEW

Turn daily offers into a stylish display with the A-Board Grab & Grip Black. Featuring black double-sided BOND boards, it offers an affordable alternative to classic chalkboards. Create your messages with liquid chalk markers, and highlight your branding with a vivid top imprint that lasts. Lightweight and easy to set up using the grips, it is ideal for fast-paced promotions and high-traffic areas.

page 98



### BEACH CHAIR RELAX CLASSIC

NEW

A classic that never fades! Classic, comfortable, and customisable — the Relax Classic offers timeless design at an affordable price. Featuring three recline positions, a sanded finish free of sharp edges, and safeguards to prevent accidental folding, it's perfect for terraces, events, or chill-out zones. The self-change fabric system makes updates easy — just slide the wooden fixing bar into the fabric sleeve, wrap it over the frame, and secure it in place. Add an optional back banner for even more promotional space!

page 298

# POINT OF SALE

Punto di Vendita  
Punto de Venta  
Point de vente

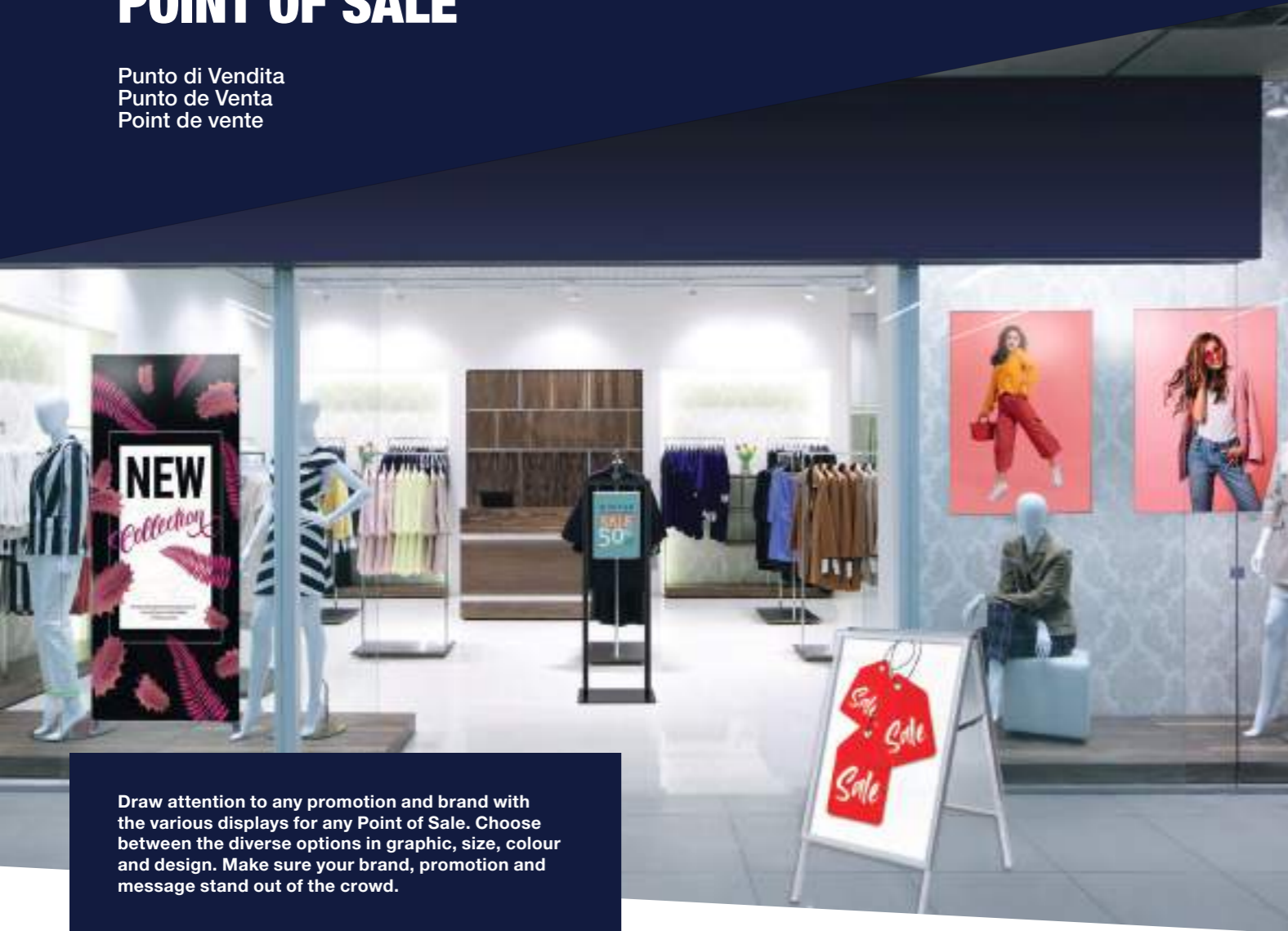

Draw attention to any promotion and brand with the various displays for any Point of Sale. Choose between the diverse options in graphic, size, colour and design. Make sure your brand, promotion and message stand out of the crowd.



**TEXTILE FRAME ELEGANT BLACK**  
See 2. Textile Frames  
page 44

**LED SLIDE IN FRAME SLIM**  
See 3. Illuminated Displays  
page 50



**DIGITAL A-BOARD SPECTRUM**  
See 4. Digital Displays  
page 77



**TRIGRIP STAND STEEL**  
See 4. Digital Displays  
page 82



**NEW**



**A-BOARD SLIDE-IN**  
See 5. Pavement Signs  
page 96

**STREAMLINE DIGITAL TOTEM**  
See 4. Digital Displays  
page 68



**DIGITAL COUNTER FUTURO**  
See 4. Digital Displays  
page 80



**NEW**



**DIGITAL TOTEM SKY GO**  
See 4. Digital Displays  
page 67

**SMART LINE DIGITAL A-BOARD**  
See 4. Digital Displays  
page 76



**SMART LINE DIGITAL PANEL**  
See 4. Digital Displays  
page 75

**POSTER DISPLAY SWING**  
See 1. Poster Frames and Displays  
page 33



topcard with print  
now available

**WINDTALKER® CITY WITH PLASTIC BASE**  
See 5. Pavement Signs  
page 102



**POSTER DISPLAY DECOR CLICK**  
See 1. Poster Frames and Displays  
page 35



**POSTER DISPLAY DECOR SWAY**  
See 1. Poster Frames and Displays  
page 34

## interesting categories for you

1. POSTER FRAMES AND DISPLAYS	14
2. TEXTILE FRAMES	38
3. ILLUMINATED DISPLAYS	48
4. DIGITAL DISPLAYS	62
5. PAVEMENT SIGNS	86
6. LEAFLET AND CATALOGUE HOLDERS	106
8. MENU DISPLAYS	128
10. LOCKABLE NOTICE BOARDS	154
12. WAYFINDING SYSTEMS	178
15. BANNERS	206
16. FLAGS	234



**ZIPPER-WALL BANNER**  
See 15. Banners  
page 224



**ZIPPER-BANNER TRIANGLE**  
See 15. Banners  
page 228

# 1. POSTER FRAMES AND DISPLAYS

Porta poster e Espositori  
Marcos para Póster y Expositores  
Cadres et présentoirs d'affiches

A perfect display to present posters, photographs or showcase art. Thanks to the diverse range of products you always find the solution. Ensure an effortless exchange of graphics in just a few seconds. From simple to more decorative designs, the Poster Frames and Displays ensure an elegant look. Available in different sizes and colours.

➤ **WIDE RANGE OF PRODUCTS, PROFILE WIDTHS AND DESIGNS**

➤ **QUICK AND EASY CHANGE OF POSTER**

➤ **POSSIBLE TO BRAND WITH SILK SCREEN PRINT LOGO**

## INDEX

1.1 Snap Frames **18**  
Cornici a scatto  
Marco para Póster  
Cadres Clic Clac

1.2 Poster Frames **26**  
Porta poster  
Marco para Póster  
Cadres Poster

1.3 Poster Displays **30**  
Espositori  
Porta Póster  
Panneaux d'Affichage

1.4 Appendo Cable Systems **37**  
Porta poster con cavetti  
Appendo Systems  
Sistemas de Cable  
Appendo  
Systèmes de Câblage  
Appendo



### ✓ GOOD 25 MM SNAP FRAME STANDARD

- Bestseller profile width 25 mm
- Perfect solution for poster sizes A5 up to A0
- Mitred or rounded corners

### 👍 BETTER 37 MM SNAP FRAME COMPASSO®

- Unique aluminium frame design
- Premium double frame look
- Anti-glare foil for optimal poster protection

### 🏆 BEST LOCKABLE POSTER CASE ECONOMY

- Lockable poster case with enhanced security
- Impact resistant
- Profile 37 mm

# 1. POSTER FRAMES

## SNAP FRAMES

- Anti-glare front cover with snap shut profiles
- For wall fix applications (ceiling suspension hooks provided on request)
- Screws and wall plugs are included
- Supplied individually boxed



**Quick and easy poster change without removing from the wall**  
Snap open the sides, place your poster behind the anti-glare sheet and snap shut.

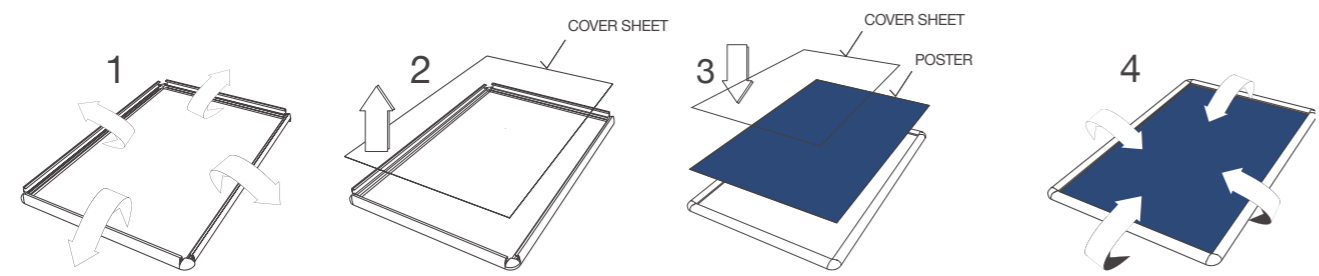

## 1.1 SNAP FRAMES

### 37 MM SNAP FRAME COMPASSO®

- IT**
- Cornice in alluminio con un design unico
  - Effetto doppia cornice Premium
  - Copertura antiriflesso per una protezione ottimale delle locandine
- ES**
- Diseño exclusivo de marco de aluminio
  - Estética de doble perfil Premium
  - Folio protector antirreflejante para la óptima protección de la gráfica
- FR**
- Cadre unique en aluminium
  - Cadre double de qualité
  - Film anti-reflet pour une protection optimale des posters

Art. nr.	DIN/Size	Dimensions (cm)			
		W	H	D	KG
KRA4G37	A4	26,4	35,1	1,3	0,7
KRA3G37	A3	35,1	47,4	1,3	1
KRA2G37	A2	47,4	64,8	1,3	1,5
KRA1G37	A1	64,8	89,5	1,3	2,3
KRA0G37	A0	89,5	124,3	1,3	3,6

#### Including splashproof Poster Bag

KRA4G37WR	A4	26,4	35,1	1,3	0,8
KRA3G37WR	A3	35,1	47,4	1,3	1,1
KRA2G37WR	A2	47,4	64,8	1,3	1,6
KRA1G37WR	A1	64,8	89,5	1,3	2,8
KRA0G37WR	A0	89,5	124,3	1,3	4,7

- Other sizes and colours available on request
- All codes that include WR are for outdoor use (IP53)



### 20 MM SNAP FRAME SLIM

- IT**
- Aspetto sottile grazie alla curva di profilo superficiale
  - Bordi squadretti o arrotondati
  - Soluzione perfetta per locandine nei formati da A5 ad A1
- ES**
- Aspecto sutil debido a la curva de perfil superficial
  - Esquinas en forma redondeada o inglete
  - Solución perfecta para gráficas más pequeñas desde DIN A5 hasta A1
- FR**
- Aspect délicat grace à la courbe de profil faible
  - Coins biseautés ou arrondis
  - Solution idéale pour les petits posters de format A5 à A1 mm

Art. nr.	DIN/Size	Dimensions (cm)			
		W	H	D	KG
<b>Mitred corner</b>					
KRA5G20	A5	17,7	23,9	1,1	0,3
KRA4G20	A4	23,9	32,6	1,1	0,6
KRA3G20	A3	32,6	44,9	1,1	0,9
KRA2G20	A2	44,9	62,3	1,1	1,4
KRA1G20	A1	62,3	87	1,1	2,3

<b>Rounded corner</b>					
KRA5R20	A5	17,7	23,9	1,1	0,3
KRA4R20	A4	23,9	32,6	1,1	0,6
KRA3R20	A3	32,6	44,9	1,1	0,9
KRA2R20	A2	44,9	62,3	1,1	1,4
KRA1R20	A1	62,3	87	1,1	2,3

- Splashproof Poster Bag, Hanging Hooks and Support optional for all Snap Frames (see p. 25)

20 mm Snap Frame Slim (p. 19/ch. 1) and Barrier Flexi Belt Post (p. 190/ch. 12)



### 15 MM SNAP FRAME

- IT**
- Perfetta per locandine nei formati da A5 ad A1
  - Sostituzione rapida locandine
  - Bordi squadretti
- ES**
- Perfecto para gráficas desde DIN A5 hasta DIN A1
  - Cambio rápido de la gráfica
  - Esquinas en inglete
- FR**
- Idéal pour les posters de format A5 à A1
  - Remplacement rapide du poster
  - Coins biseautés

Art. nr.	DIN/Size	Dimensions (cm)			
		W	H	D	KG
KRA5G15	A5	16	22,2	1,3	0,3
KRA4G15	A4	22,2	30,9	1,3	0,5
KRA3G15	A3	30,9	43,2	1,3	0,7
KRA2G15	A2	43,2	60,6	1,3	1,1
KRA1G15	A1	60,6	85,3	1,3	1,8



25 MM SNAP FRAME STANDARD

BESTSELLER

- IT**
  - Profilo bestseller con un'ampiezza di 25 mm
  - Soluzione perfetta per locandine nei formati da A5 fino ad A0
  - Bordi squadrati o arrotondati
- ES**
  - Perfil de 25 mm de ancho, el más vendido
  - Solución perfecta para gráficas de tamaño desde DIN A5 hasta DIN A0
  - Esquinas en inglete o redondeadas
- FR**
  - Profil best-seller de 25 mm de large
  - Solution parfaite pour les posters de tailles A5 à A0
  - Coins biseautés ou arrondis



Art. nr.	DIN/Size	Dimensions (cm)			
		W	H	D	KG
<b>Mitred corner</b>					
KRA5G25	A5	17,9	24,1	1,1	0,3
KRA4G25	A4	24,1	32,8	1,1	0,5
KRA3G25	A3	32,8	45,1	1,1	0,7
KRA2G25	A2	45,1	62,5	1,1	1
KRA1G25	A1	62,5	87,2	1,1	1,7
KRA0G25	A0	87,2	122	1,1	2,8
KR50x70G25	50 x 70	53,1	73,1	1,1	1,3
KR70x100G25	70 x 100	73,1	103,1	1,1	2,2

<b>Rounded corner</b>					
Art. nr.	DIN/Size	W	H	D	KG
KRA4R25	A4	24,1	32,8	1,1	0,4
KRA3R25	A3	32,8	45,1	1,1	0,6
KRA2R25	A2	45,1	62,5	1,1	1
KRA1R25	A1	62,5	87,2	1,1	1,6
KRA0R25	A0	87,2	122	1,1	2,8
KR50x70R25	50 x 70	53,1	73,1	1,1	1,3
KR70x100R25	70 x 100	73,1	103,1	1,1	2,2



Security Snap Frame is available on request

25 MM SNAP FRAME GOLD

- IT**
  - Effetto esclusivo
  - Profilo di design curvo
  - Perfetta per locandine nei formati da A4 ad A1
- ES**
  - Aspecto exclusivo
  - Perfil de diseño curvado
  - Perfecto para gráficas desde DIN A4 hasta DIN A1
- FR**
  - Look exclusif
  - Profil incurvé
  - Parfait pour les tailles de poster A4 à A1



Art. nr.	DIN/Size	Dimensions (cm)			
		W	H	D	KG
KRA4G25GOLD	A4	24,1	32,8	1,1	0,6
KRA3G25GOLD	A3	32,8	45,1	1,1	0,9
KRA2G25GOLD	A2	45,1	62,5	1,1	1,4
KRA1G25GOLD	A1	62,5	87,2	1,1	2,3



Splashproof Poster Bag, Hanging Hooks and Support optional for all Snap Frames (see p. 25)

FIRE RATED 25 MM SNAP FRAME

- IT**
  - Certificazione classe antincendio B1
  - Fondo in metallo resistente agli urti
  - Perfetta per le scuole e gli edifici pubblici
- ES**
  - Protección ignífuga con certificación B1
  - Trasera metálica resistente al impacto
  - Perfecto para colegios y administraciones públicas
- FR**
  - Protection incendie certification B1
  - Panneau arrière en métal résistant aux chocs
  - Idéal pour les écoles et les bâtiments publics



Art. nr.	DIN/Size	Dimensions (cm)			
		W	H	D	KG
KRA4G25B1	A4	24,1	32,8	1,1	0,9
KRA3G25B1	A3	32,8	45,1	1,1	1,5
KRA2G25B1	A2	45,1	62,5	1,1	2,6
KRA1G25B1	A1	62,5	87,2	1,1	4,5
KRA0G25B1	A0	87,2	122	1,1	8,3
KR50x70G25B1	50 x 70	53,1	73,1	1,1	3,3
KR70x100G25B1	70 x 100	73,1	103,1	1,1	6



Frame Hanging Kit and Hanging Hooks for Snap Frames used together due to metal backwall (see p. 25)

SNAP FRAME WOOD

- IT**
  - Soluzione economica ed elegante per poster A5 a A0
  - Sostituzione rapida dei poster
  - Aspetto autentico
- ES**
  - Solución de exposición económica y elegante para pósters de tamaño A5 a A0
  - Cambio rápido de la gráfica
  - Apariencia auténtica
- FR**
  - Solution d'affichage économique et élégante pour les posters A5 à A0
  - Remplacement rapide du poster
  - Apparence authentique



Art. nr.	DIN/Size	Dimensions (cm)			
		W	H	D	KG
KRA5G25LB	A5	17,9	24,1	1,1	0,4
KRA4G25LB	A4	24,1	32,8	1,1	0,5
KRA3G25LB	A3	32,8	45,1	1,1	0,7
KRA2G25LB	A2	45,1	62,5	1,1	1
KRA1G25LB	A1	62,5	87,2	1,1	1,7
KRA0G25LB	A0	87,2	122	1,1	2,8
KR50x70G25LB	50x70	53,1	73,1	1,1	1,3
KR70x100G25LB	70x100	73,1	103,1	1,1	2,2



Splashproof Poster Bag, Hanging Hooks and Support optional for all Snap Frames (see p. 25)

25 MM RAL COLOUR SNAP FRAME

- IT**
- Perfetta per i formati da A4 ad A0
  - Verniciatura a polvere semilucida RAL
  - Bordi squadrati
- ES**
- Perfecto desde DIN A4 hasta DIN A0
  - Acabado del RAL semi-brillante
  - Esquinas en inglete
- FR**
- Parfait pour les formats A4 à A0
  - Finition semi-brillante par revêtement en poudre RAL
  - Coins biseautés



Art. nr.	DIN/Size	Dimensions (cm)			KG
		W	H	D	
KRA4G25C9005	A4	24,1	32,8	1,1	0,6
KRA3G25C9005	A3	32,8	45,1	1,1	0,9
KRA2G25C9005	A2	45,1	62,5	1,1	1,4
KRA1G25C9005	A1	62,5	87,2	1,1	2,3
KRA0G25C9005	A0	87,2	122	1,1	4,1
KR50x70G25C9005	50 x 70	53,1	73,1	1,1	1,8
KR70x100G25C9005	70 x 100	73,1	103,1	1,1	3,1
KRA4G25C9003	A4	24,1	32,8	1,1	0,6
KRA3G25C9003	A3	32,8	45,1	1,1	0,9
KRA2G25C9003	A2	45,1	62,5	1,1	1,4
KRA1G25C9003	A1	62,5	87,2	1,1	2,3
KRA0G25C9003	A0	87,2	122	1,1	4,1
KR50x70G25C9003	50 x 70	53,1	73,1	1,1	1,8
KR70x100G25C9003	70 x 100	73,1	103,1	1,1	3,1
KRA4G25C3020	A4	24,1	32,8	1,1	0,6
KRA3G25C3020	A3	32,8	45,1	1,1	0,9
KRA2G25C3020	A2	45,1	62,5	1,1	1,4
KRA1G25C3020	A1	62,5	87,2	1,1	2,3
KRA0G25C3020	A0	87,2	122	1,1	4,1



SCRITTO® SNAP FRAME

- IT**
- Pellicola protettiva antiriflesso resistente ai raggi UV
  - Posizione orizzontale o verticale
  - Fondo in plastica rigida
- ES**
- Folio protector antirreflejos y contra rayos ultravioleta
  - Posición vertical u horizontal
  - Pared trasera de plástico duro
- FR**
- Film de protection antireflet résistant aux UV
  - Position portrait ou paysage
  - Paroi arrière en plastique dur



Art. nr.	DIN/Size	Dimensions (cm)			KG
		W	H	D	
KRA4G25ABS	A4	24,1	32,8	1,1	0,31
KRA3G25ABS	A3	32,8	45,2	1,1	0,44



- Optimal for industrial places
- Profile of 25 mm

WINDOW SNAP FRAME

- IT**
- Ideale per le vetrine dei negozi
  - Cornice biadesiva
  - Rimovibile senza lasciare tracce
- ES**
- Ideal para escaparates
  - Marco de doble cara adhesivo
  - Removible sin dejar rastro
- FR**
- Idéal pour une utilisation en atelier
  - Cadre adhésif double face
  - Amovible sans traces



Art. nr.	DIN/Size	Dimensions (cm)			KG
		W	H	D	
<b>Profile 25 mm</b>					
WKRA3G25	A3	32,8	45,1	1,1	1
WKRA2G25	A2	45,1	62,5	1,1	1,6
WKRA1G25	A1	62,5	87,2	1,1	2,6
WKRA0G25	A0	87,2	122	1,1	4,5
WKR70x100G25	70 x 100	73,1	103,1	1,1	3,3
<b>Profile 32 mm</b>					
WKR70x100G32	70 x 100	74,5	104,5	1,6	3,5



- Adhesive tape fixed Snap Frame and additional cover profiles for outside of the window

32 MM SNAP FRAME

- IT**
- Perfetta per locandine di grandi formati
  - Classico profilo solido da 32 mm
  - Fondo altamente resistente agli urti
- ES**
- Perfecto para gráficas de gran tamaño
  - Perfil robusto y clásico de 32 mm
  - Trasera de alta resistencia a impactos
- FR**
- Parfait pour les grands posters
  - Profilé solide et classique de 32 mm
  - Paroi arrière résistante aux chocs



Art. nr.	DIN/Size	Dimensions (cm)			KG
		W	H	D	
<b>Mitred corner</b>					
KRA3G32	A3	34,2	46,5	1,6	1,2
KRA2G32	A2	46,5	63,9	1,6	1,6
KRA1G32	A1	63,9	88,6	1,6	2,9
KRA0G32	A0	88,6	123,4	1,6	5,2
KR50x70G32	50 x 70	54,5	74,5	1,6	2,2
KR70x100G32	70 x 100	74,5	104,5	1,6	3,1
KR100x140G32	100 x 140	104,5	144,5	1,6	6,6
<b>Rounded corner</b>					
KRA3R32	A3	34,2	46,5	1,6	1,1
KRA2R32	A2	46,5	63,9	1,6	1,6
KRA1R32	A1	63,9	88,6	1,6	2,8
KRA0R32	A0	88,6	123,4	1,6	5,1
KR50x70R32	50 x 70	54,5	74,5	1,6	2,2
KR70x100R32	70 x 100	74,5	104,5	1,6	3,1
KR100x140R32	100 x 140	104,5	144,5	1,6	6,6



- Security Snap Frame is available on request

## FIRE RATED 32 MM SNAP FRAME

- IT**
- DIN4102 classe antincendio B1
  - Cornice nella versione con la massima durata
  - Ideale per scuole eD edifici pubblici
- ES**
- Protección ignífuga B1 (DIN4102)
  - Versión de marco de más durabilidad
  - Ideal para colegios y administraciones públicas
- FR**
- Protection B1 contre les incendies DIN4102
  - Version cadre avec la plus grande durabilité
  - Idéal pour les écoles et les bâtiments publics



Art. nr.	DIN/Size	Dimensions (cm)			
		W	H	D	KG
KRA3G32B1	A3	34,2	46,5	1,6	1,8
KRA2G32B1	A2	46,5	63,9	1,6	3
KRA1G32B1	A1	63,9	88,6	1,6	5,1
KRA0G32B1	A0	88,6	123,4	1,6	9
KR50x70G32B1	50 x 70	54,5	74,5	1,6	3,7
KR70x100G32B1	70 x 100	74,5	104,5	1,6	6,5

ⓘ For suspension use Frame Hanging Kit and Hanging Hooks for Snap Frames together, due to metal back wall (see p. 25)

37 mm Snap Frame Compasso® (p. 18/ch. 1)

## SPLASHPROOF POSTER BAG

Accessory for Snap Frames, A-Boards and Windtalkers®



- IT**
- Durata della locandina maggiore - busta in PVC resistente ai raggi UV
- ES**
- Vida útil prolongada del póster: bolsa de PVC resistente a los rayos UV
- FR**
- Prolongation de la durée de vie des affiches - enveloppe en PVC résistant aux UV

ⓘ IP53 splashproof

Art. nr. WRBAGA4  
WRBAGA3  
WRBAGA2  
WRBAGA1  
WRBAG50x70  
WRBAG70x100

## HANGING HOOKS FOR SNAP FRAMES (2 PCS)

Accessory for all Snap Frames



- IT**
- Installazione della Cornice a Scatto semplice e veloce
- ES**
- Instalación de marco rápida y sencilla
- FR**
- Installation simple et rapide du cadre clic-clac d'affichage

Art. nr. HHKR

## FRAME HANGING KIT

Accessory for Fire Rated 25 mm Snap Frame, Fire Rated 32 mm Snap Frame and Postersnapper



- IT**
- Kit di montaggio per sospensione da soffitto
- ES**
- Set de suspensión para suspensión de techo
- FR**
- Ensemble de suspension pour suspension au plafond

Art. nr. HSKR

## POSTER FOIL, FOIL SET

Accessory for Snap Frames and A-Boards



- IT**
- Copertura locandina stabile ai raggi UV antiriflesso
- ES**
- Folio protector antirreflejos y anti-UV
- FR**
- Protection antireflet résistante aux UV pour les posters

Art. nr.	Foil (5 pcs)	Foil Set (2 pcs)
	FOILA4	SETFZPA4
	FOILA3	SETFZPA3
	FOILA2	SETFZPA2
	FOILA1	SETFZPA1
	FOILA0	SETFZPA0
	FOIL50x70	SETFZP50x70
	FOIL70x100	SETFZP70x100



## POSTERSNAPPER

**BESTSELLER**

- IT**
- Presentazione locandina rapida ed economica
  - Guida da 25 mm su due lati, superiore e inferiore
  - Trasporto e montaggio semplici
- ES**
- Presentación de gráfica rápida y económica
  - Riel de sujeción de 25 mm superior e inferior
  - Fácil de transportar y montar
- FR**
- Présentation rapide et bon marché du poster
  - Rail à pression de 25 mm en haut et en bas
  - Transport et montage faciles

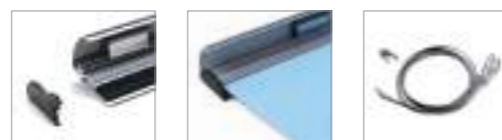

Art. nr.	DIN/Size	Dimensions (cm)			
		W	H	D	KG
PP30	29,7 x 30,2	30,5	45	1,2	0,2
PP42	42 x 42,5	42,5	62,4	1,2	0,3
PP50	50 x 50,5	50,5	73	1,2	0,3
PP60	59,4 x 59,9	60	87,1	1,2	0,4
PP70	70 x 70,5	70,5	103	1,2	0,4
PP85	84,1 x 84,6	84,5	121,9	1,2	0,5
PP100	100 x 100,5	100,5	143	1,2	0,6
PP120	120 x 120,5	120,5	123	1,2	0,7
PP150	150 x 150,5	150,5	153	1,2	0,9

Optional: Frame Hanging Kit (see p. 25)

## POSTERSTRETCH® DISPLAY

- IT**
- Struttura leggera in alluminio anodizzato
  - Le pinze a cocodrillo mantengono la locandina in perfetta posizione
  - Profilo tubolare ovale con chiusura a scatto negli angoli color argento
- ES**
- Construcción en aluminio anodizado ligero
  - Pinzas de sujeción para mantener su gráfica en perfecta posición
  - Perfil tubular introducido en esquinas de color gris plata
- FR**
- Structure en aluminium à motif anodisé clair
  - Les pinces crocodile maintiennent parfaitement le poster
  - Profil de tube ovale avec coins gris argenté à enfoncer

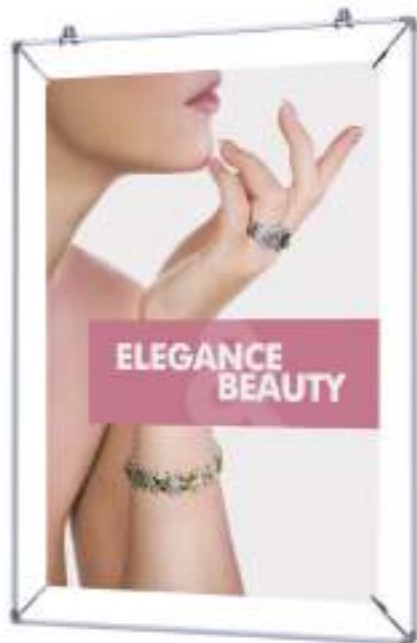

Art. nr.	DIN/Size	Dimensions (cm)			
		W	H	D	KG
PSO1	A1	70	94,7	1,2	0,3

Frame Hanging Kit Suction Cups  
SUCTIONCUPS

## INFOTOPPER

- IT**
- Autoportante con fissaggio con nastro adesivo
  - Resistente alle intemperie (antispruzzo)
  - Ideale per l'esposizione di locandine all'esterno
- ES**
- Independiente
  - Resistente a la intemperie (a prueba de salpicaduras)
  - Ideal para presentación en exteriores
- FR**
- Sur pied
  - Résistant aux intempéries (éclaboussures)
  - Idéal pour la présentation de posters en extérieur



Art. nr.	DIN/Size	Dimensions (cm)			
		W	H	D	KG
ITA4	A4	32,8	23,6	4,4	0,9
ITA3	A3	45,1	32,3	4,4	1,3

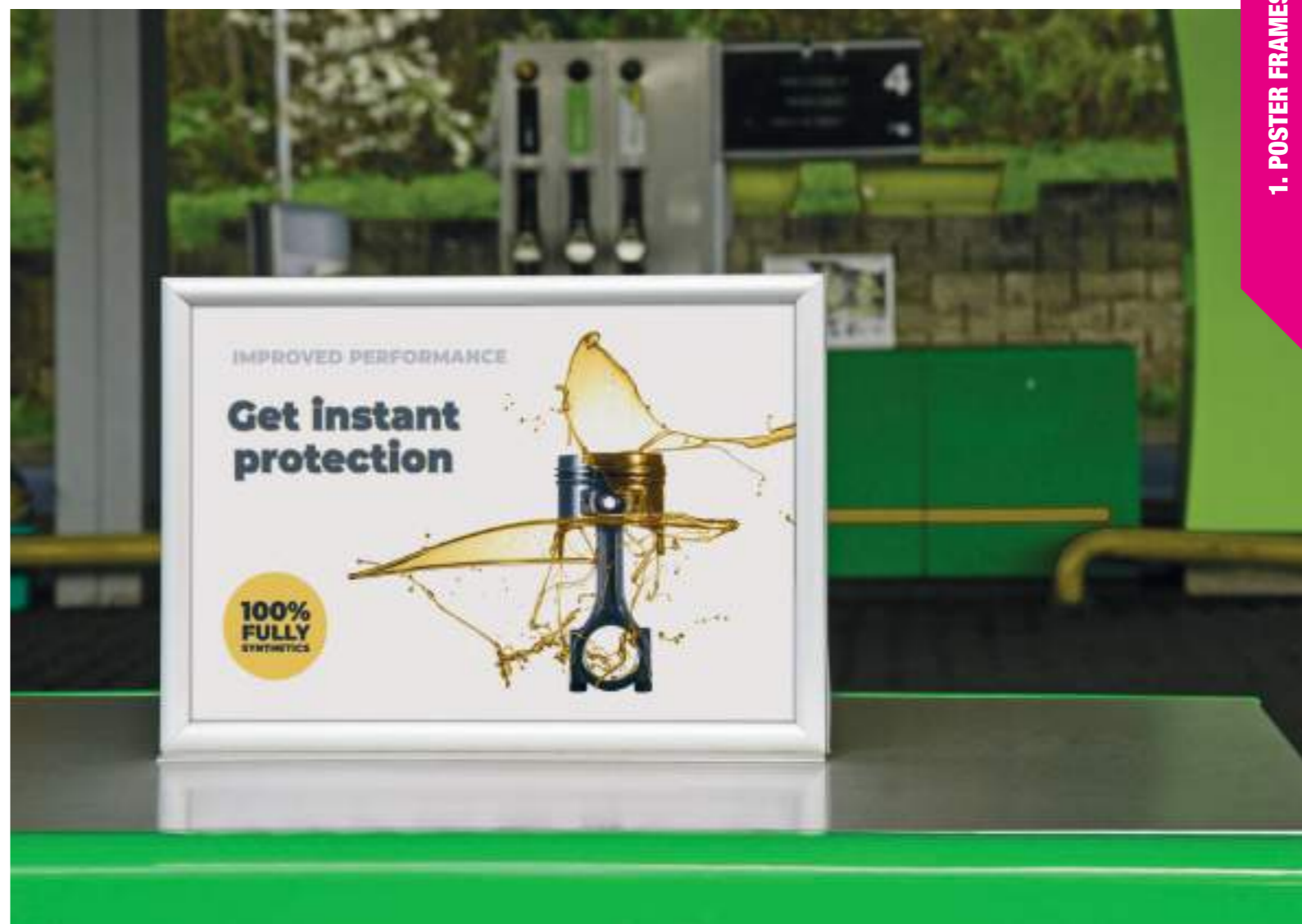

## LOCKABLE POSTER CASE ECONOMY

**BESTSELLER**

- IT**
  - Bacheca con serratura che offre una maggiore sicurezza
  - Resistente agli urti
  - Profilo da 37 mm con fondo in plastica
- ES**
  - Un Portaposter con el cierre de seguridad mejorado
  - Resistente al impacto
  - Perfil de 37 mm con pared posterior de plástico
- FR**
  - Boîtier pour poster verrouillable avec sécurité renforcée
  - Résistant aux chocs
  - Profilé de 37 mm avec paroi arrière en plastique



Art. nr.	DIN/Size	Dimensions (cm)			
		W	H	D	KG
SCPA4	A4	26,6	35,3	2,3	1,5
SCPA3	A3	35,3	47,6	2,3	2
SCPA2	A2	47,6	65	2,3	2,8
SCPA1	A1	65	89,7	2,3	4,2
SCPA0	A0	89,7	124,5	2,3	6,6
SCP70x100	70 x 100	75,6	105,6	2,3	5,2



## MAGNETIC POSTER FRAME SLIM

- IT**
  - Design sofisticato e snello
  - Facile sostituzione del poster grazie alla ventosa
  - Pannello resistente ai raggi UV e antiriflesso
- ES**
  - Diseño sofisticado y estilizado
  - Fácil de cambiar el poster gracias a la ventosa
  - Panel frontal sin reflejos y resistente a los rayos UV
- FR**
  - Conception sophistiquée et fine
  - Changement facile de l'affiche grâce à la ventouse
  - Face avant résistante aux UV et anti-éblouissement



Art. nr.	DIN/Size	Dimensions (cm)			
		W	H	D	KG
PEFA4C9005	A4	23,5	32,2	6	0,7
PEFA3C9005	A3	32,2	44,5	6	1,2
PEFA2C9005	A2	44,5	61,7	6	2,2
PEFA1C9005	A1	61,7	86,5	6	4,1



## CATCHING POLE DESIGN STANDARD

- IT**
- 25 mm Cornice a scatto (monofacciale o bifacciale)
  - Uso flessibile in aree interne ed esterne coperte
  - Cornice a scatto con angoli vivi o arrotondati
- ES**
- Marco abatible de 25 mm (una cara o dos caras)
  - Uso flexible para interior y exterior cubierto
  - Marco abatible con con esquinas redondeadas o unidas en inglete
- FR**
- Cadre clic-clac de 25 mm (simple ou double face)
  - Utilisation flexible pour les zones intérieures et extérieures couvertes
  - Cadre clic-clac avec coins biseautés ou ronds

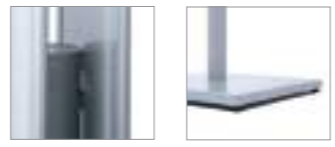

Art. nr.	Corner shape	DIN/Size	Dimensions (cm)			
			W	H	D	KG
<b>Single-sided</b>						
CAPOA4G25	Mitred	A4	33	140,4	33	4,9
CAPOA3G25	Mitred	A3	33	146,5	33	5,5
CAPOA4R25	Rounded	A4	33	140,4	33	4,9
CAPOA3R25	Rounded	A3	33	146,5	33	5,5
<b>Double-sided</b>						
CAPOA4G25D	Mitred	A4	33	140,4	33	5,2
CAPOA3G25D	Mitred	A3	33	146,5	33	6
CAPOA4R25D	Rounded	A4	33	140,4	33	5,2
CAPOA3R25D	Rounded	A3	33	146,5	33	6

## POSTER FRAME STAND

- IT**
- Ideale per locandine di grandi formati
  - Design elegante bifacciale con Cornice a Scatto da 25 mm
  - Base pesante in metallo verniciata a polvere per una stabilità estrema
- ES**
- Idóneo para gráficas en formatos grandes
  - Estructura elegante con marco abatible de 25 mm
  - Base metálica sólida con revestimiento en polvo para mayor estabilidad
- FR**
- Idéal pour les posters grands formats
  - Structure élégante avec cadre clic-clac de 25 mm
  - Lourde base métallique thermolaquée pour une stabilité extrême

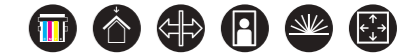
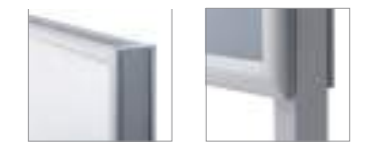

Art. nr.	DIN/Size	Dimensions (cm)			
		W	H	D	KG
PFSA1D	A1	63,1	130,5	33	15,1
PFS70x100D	70 x 100	73,7	130,5	33	17,9

Brochure Holder Design Standard (p. 108/ch. 6) and Poster Frame Stand (p. 31/ch. 1)

## INFO BOARD DESIGN STANDARD

- IT**
- Cornice pubblicitaria monofacciale o bifacciale
  - Estremamente stabile
  - Possibilità di aggiungere ripiano per brochure
- ES**
- Marco para pósteres de una y dos caras
  - Extremadamente estable
  - Opción de añadir estantería
- FR**
- Cadre pour affiche simple et double face
  - Extrêmement stable
  - Possibilité d'ajouter une étagère pour brochures



Art. nr.	DIN/Size	Dimensions (cm)			
		W	H	D	KG
<b>Single-sided</b>					
IBA1G25	A1	71,5	185	50	12,2
IB70x100G25	70 x 100	82	185	50	13,1
<b>Double-sided</b>					
IBA1G25D	A1	71,5	185	50	13,9
IB70x100G25D	70 x 100	82	185	50	15,3



## INFO POLE DESIGN STANDARD

- IT**
- Base stabile e robusta in metallo
  - Cornice a scatto in alluminio da 25 mm con angolo vivo
  - Facile sostituzione del poster
- ES**
- Base metálica estable
  - Marco abatible de aluminio de 25 mm con esquinas unidas en inglete
  - Reemplazo de póster fácil
- FR**
- Base métallique stable
  - Cadre clic-clac en aluminium de 25 mm avec coins biseautés
  - Changement facile du poster



Art. nr.	Corner shape	DIN/Size	Dimensions (cm)			
			W	H	D	KG
<b>Single-sided</b>						
IPM2A1G25	Mitred	A1	62,5	181,5	42,5	15,9
<b>Double-sided</b>						
IPM2A1G25D	Mitred	A1	62,5	181,5	42,5	17,5

Graphic available

Poster Display Swing (p. 33/ch. 1), Textile Frame Elegant Black (p. 44/ch. 2)

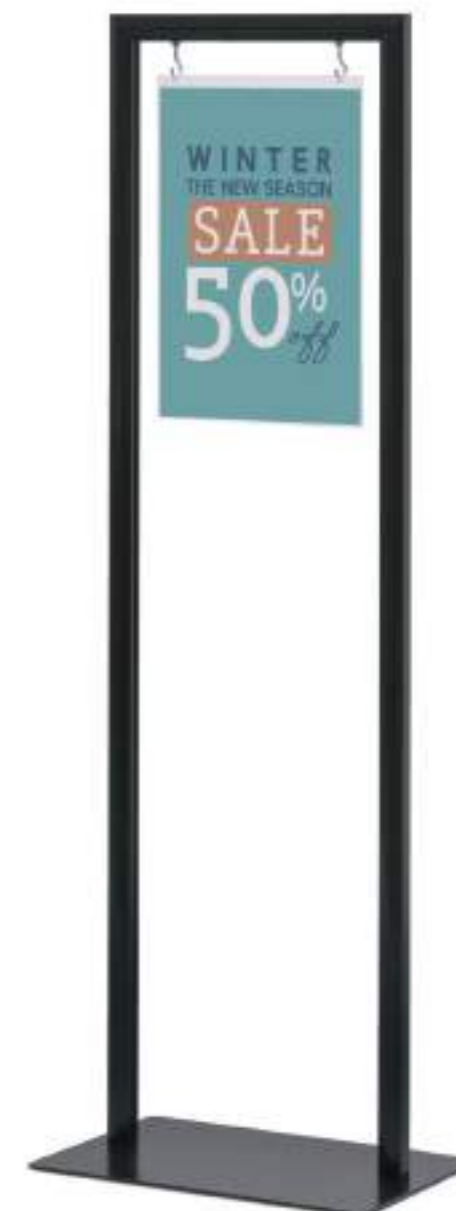

## POSTER DISPLAY SWING

- IT**
- Design sottile classico e leggero
  - Alternativa conveniente all'Espositore Pubblicitario
  - Facile scambio di locandine con tasca in vetro acrilico bifacciale
- ES**
- Diseño clásico, ligero y fino.
  - Una alternativa económica a los Portaposters
  - Cambio de poster fácil gracias a la carpeta acrílica de doble cara
- FR**
- Design fin, classique et léger
  - Alternative rentable pour l'affichage de posters
  - Échange facile des posters grâce à une pochette acrylique double-face

Art. nr.	DIN/Size	Dimensions (cm)			
		W	H	D	KG
SWSDA4	A4	34	115	28	3,7

Perfect solution in retail, hospitality and public spaces



Graphic available



POSTER DISPLAY DECOR CLICK

- IT**
  - Formato esclusivamente bifacciale
  - Struttura interamente in alluminio
  - Colore nero o argento
- ES**
  - Formato exclusivo de doble cara
  - Construcción de aluminio
  - Color negro o plateado
- FR**
  - Format exclusivement recto verso
  - Conception entièrement en aluminium
  - Couleur noire ou argentée



Art. nr.	DIN/Size	Dimensions (cm)			
		W	H	D	KG
PDCLA1DC9005	● A1	63	179,2	53,6	5,9
PDCL2xA1DC9005	● 2 x A1	63	179,2	53,6	8,8
PDCLA1D	○ A1	63	179,2	53,6	5,9
PDCL2xA1D	○ 2 x A1	63	179,2	53,6	8,8



POSTER DISPLAY DECOR SWAY

- IT**
  - Struttura interamente in alluminio
  - Elegante tasca in acrilico
  - Espositore bifacciale per poster
- ES**
  - Construcción completamente de aluminio
  - Elegante carpeta acrílica
  - Promoción a doble cara
- FR**
  - Construcción completamente de aluminio
  - Elegante carpeta acrílica
  - Promoción a doble cara



Art. nr.	DIN/Size	Dimensions (cm)			
		W	H	D	KG
PDSWA2C9005	● A2	56	180,7	45	4,5
PDSWA1C9005	● A1	73,4	180,7	45	5,6
PDSWA2	○ A2	56	180,7	45	4,5
PDSWA1	○ A1	73,4	180,7	45	5,6



## TRIBOARD DESIGN STANDARD

- IT**
  - Opzione permanente grazie a fori predisposti sulla base
  - Adatto a un uso esterno coperto
  - Attira l'attenzione da ogni lato
- ES**
  - Opción permanente gracias a los agujeros preperforados en la base
  - Adecuado para su uso en exteriores cubiertos
  - Atracción desde cualquier lado
- FR**
  - Option permanente grâce à des trous pré-perçés dans la base
  - Convient pour une utilisation extérieure couverte
  - Attire l'attention de tous les côtés



Art. nr.	DIN/Size	Dimensions (cm)			
		W	H	D	KG
TBA1M	A1	74,4	181	64,5	20,7
TBA0M	A0	99,1	181	85,8	31,1

## INFO POST DESIGN SLIM

- IT**
  - Di facile utilizzo
  - Economico
  - Facile accesso alla struttura
- ES**
  - Fácil de usar
  - Bajo coste
  - Construcción con deslizamiento cómodo
- FR**
  - Facile à utiliser
  - Economique
  - Conception pratique à glissière



Art. nr.	DIN/Size	Dimensions (cm)			
		W	H	D	KG
IPOA4	A4	26	134,2	26	3,9
IPUA4	A4	26	131,5	26	2,7

## APPENDO E-CLIP KIT

- IT**
  - Montaggio semplice e veloce
  - Sistema espositivo a cavetto con 5 tasche in metacrilato formato A4
  - Include fissaggi e morsetti tasche
- ES**
  - Montaje rápido y fácil
  - Sistema de cables con 5 carpetas de metacrilato de tamaño DIN A4
  - Incluye pinzas y fijación
- FR**
  - Rapide et facile à assembler
  - Système d'affichage avec câble 5 pochettes A4 en acrylique
  - Fixations et pinces de pochettes incluses



Art. nr.	Dimensions (cm)			
	W	H	D	KG
APPECCKIT	25,5	400	1	2,4

Poster display is suitable in both orientations, portrait and landscape

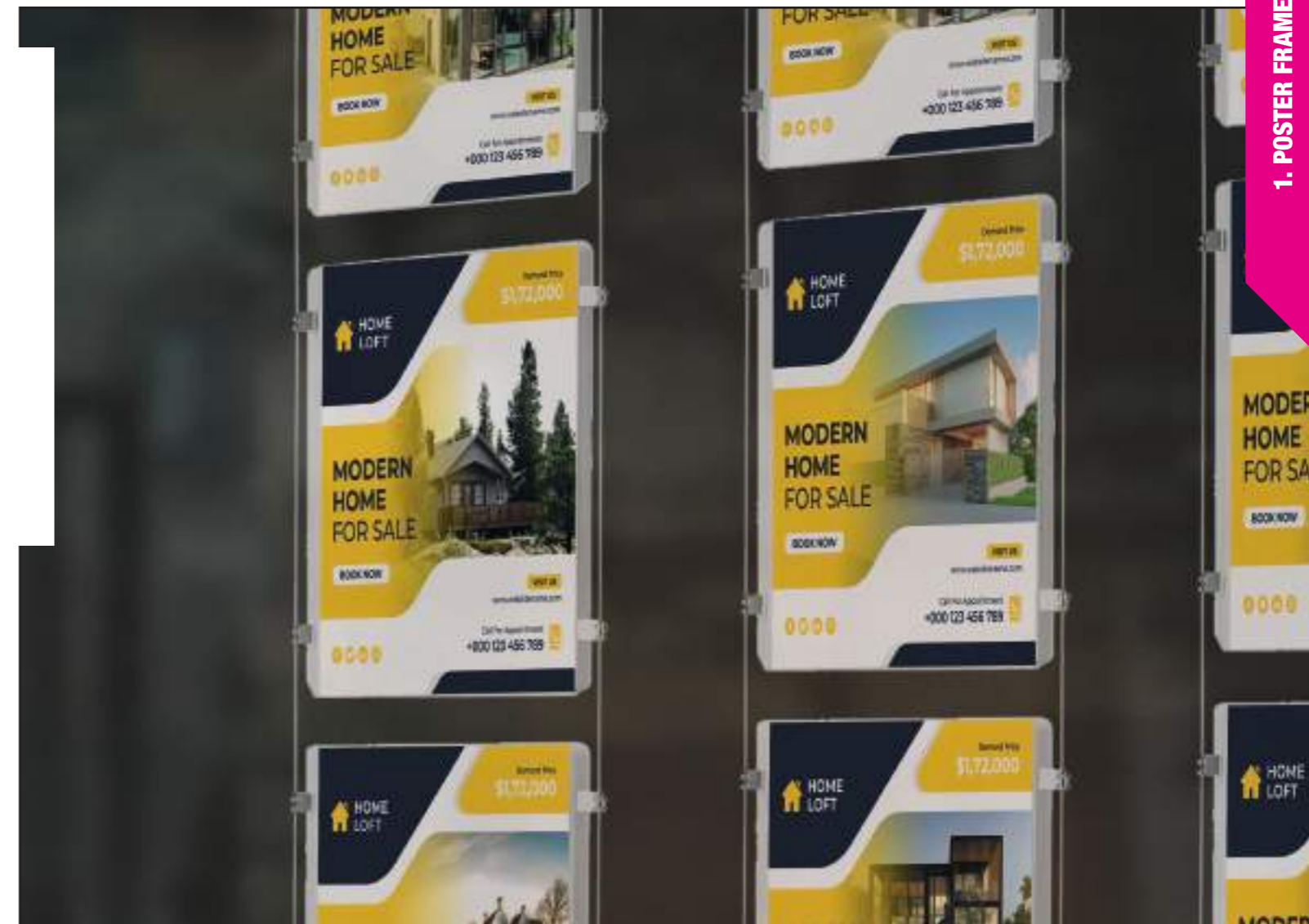

## 2. TEXTILE FRAMES

**Cornici per tessuto**  
**Marco Textil**  
**Cadres Textiles**

Textile Frames in combination with silicone edge graphics (SEG) create a stunning visual impact. A minimalistic display solution with a frameless appearance. Optional internal illumination using LED lighting. Easy to install on site and no tools required to exchange the graphics.



### INDEX

2.1 Textile Frames **42**  
 Cornici per tessuto  
 Marco Textil  
 Cadres Textiles



- **FRAMELESS APPEARANCE DUE TO THE FLAT SIDED ALUMINIUM FRAME**
- **EASY GRAPHIC EXCHANGE WITHOUT TOOLS OR THE NEED TO REMOVE FROM THE WALL**
- **INTERNAL ILLUMINATION USING CONTINUOUS LED LIGHTING**

### ✓ GOOD TEXTILE FRAME WALL MODEL / LED

- Classic SEG frame design with only 30 mm depth for non-illuminated solutions
- 75 mm depth LED version contains Fresnel LED lenses that are pre-mounted at inner side of the profile
- Very easy attachment to the wall with direct mounting holes (non-LED) or steel wall mounts (with LED)

### 👍 BETTER TEXTILE FRAME SUSPENDED MODEL / LED

- Double-sided tension frame for hanging from the ceiling
- LED version contains Fresnel LED lenses that are pre-mounted at inner side of the profile
- Including hanging hooks and 2 m steel cable

### 🏆 BEST TEXTILE FRAME ELEGANT BLACK MODEL / LED

- Stylish and unique black thin profile of 22 mm
- Delivered assembled
- Great for hospitality, retail or office market



## 'ADVERTISEMENT IN EVERY SIZE'

### TENSIONED FABRIC SYSTEM

Take your advertising to the next level with the Textile Frames. The minimalist display solution consists of a flat sided aluminium frame and tensioned fabric graphic with silicone edges. Important to know: the solution should only be used indoors. The Textile Frames are available in various models that will fulfill your wishes: illuminated, non-illuminated, single-sided and double-sided, freestanding, wall mounted or ceiling suspended. Every solution in your suitable size. From a small solution to a larger LED illuminated custom size solution for wall and freestanding applications. The depth of the profile is the main difference.



### CONNECT TO IMPRESS

Textile Frames can be used both individually and segmented, allowing you to connect them in series to achieve stunning visual displays such as walls and backdrops. In that case additional supporting profiles are used inside the frame, behind the fabric. Segmented constructions allow for larger frame sizes with the inclusion of additional connectors, screws and bases.

### EASY TO USE

Another important advantage is that the Textile Frames are an easy to use product. The solution can easily be installed on site.

### CHANGE YOUR FABRIC GRAPHICS

The graphics can be exchanged without tools or the need to remove the solution from the wall. Fabric graphics are not included with the product but can be requested separately. Prices for all variations are available on request.

TEXTILE FRAME TOWER

- IT**
  - Espositore a torre a quattro lati
  - Un'attrazione per gli spazi pubblici
  - Leggero ma robusto
- ES**
  - Expositor a cuatro caras
  - Espectacular para espacios públicos
  - De estructura ligera pero robusta
- FR**
  - Tour de présentation à quatre faces
  - Un coup de cœur dans les espaces publics
  - Léger, mais robuste



Art. nr.	DIN/Size	Dimensions (cm)			
		W	H	D	KG
TFRTOWER60x200	60 x 200	60	200,8	66	10,5
TFRTOWER85x200	85 x 200	85	200,8	91	10,9
TFRTOWER100x200	100 x 200	100	200,8	106	11,4



Other sizes and profile depths available on request

TEXTILE FRAME SUSPENDED MODEL / LED

- IT**
  - Cornice con Tessuto in tensione bifacciale per fissaggio al soffitto
  - La versione LED contiene lenti LED Fresnel che sono preassemblate nella parte interna del profilo
  - Include ganci di montaggio e cavo d'acciaio da 2 m
- ES**
  - Marco tensado de doble cara para colgar del techo
  - La versión LED incluye lentes LED Fresnel que están premontadas en el lado interno del perfil
  - Incluye ganchos para colgar y cable de acero de 2 m
- FR**
  - Cadre de tension double face pour suspension au plafond
  - La version LED comprend des diodes LED Fresnel préinstallées sur la face intérieure du profil
  - Crochets de suspension et câble en acier de 2 m inclus



Art. nr.	DIN/Size	Dimensions (cm)			
		W	H	D	KG
TFR50HA1	A1	59,4	84,1	5	4
TFR50HA0	A0	84,1	118,9	5	5,3
TFR50H200x100	200 x 100	200	100	5	8,1
<b>LED</b>					
TFR90HA1LED	A1	59,4	84,1	9	5,8
TFR90HA0LED	A0	84,1	118,9	9	7,2
TFR90H200x100LED	200 x 100	200	100	9	11,1

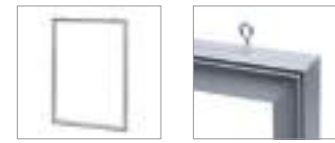

Other sizes and profile depths available on request

TEXTILE FRAME WALL MODEL / LED

- IT**
  - Design cornice SEG classico con solo 30 mm di profondità per soluzioni non illuminate
  - La versione LED profonda 75 mm contiene lenti LED Fresnel che sono preassemblate nella parte interna del profilo
  - Fissaggio alla parete molto semplice con fori per montaggio diretto (non LED) o montaggio a parete in acciaio (con LED)
- ES**
  - Diseño clásico del marco SEG con sólo 30 mm de profundidad para soluciones no iluminadas
  - La versión LED de 75 mm de profundidad incluye lentes LED Fresnel premontadas en la parte interior del perfil
  - Fijación muy fácil a la pared con orificios de montaje directo (sin LED) o soportes de acero para pared (con LED)
- FR**
  - Cadre SEG classique avec une profondeur de seulement 30 mm pour les solutions non lumineuses
  - La version LED de 75 mm de profondeur contient des lentilles LED de Fresnel qui sont pré-montées sur la face intérieure du profilé
  - Fixation murale très simple grâce aux trous de fixation (sans LED) ou aux supports muraux en acier (avec LED)



Art. nr.	DIN/Size	Dimensions (cm)			
		W	H	D	KG
TFR30WA1	A1	59,4	84,1	3	1,5
TFR30WA0	A0	84,1	118,9	3	2
TFR30W200x100	200 x 100	200	100	3	2,9
<b>LED</b>					
TFR75WA1LED	A1	59,4	84,1	7,5	4,3
TFR75WA0LED	A0	84,1	118,9	7,5	5,6
TFR75W200x100LED	200 x 100	200	100	7,5	9,7



Other sizes and profile depths available on request



### TEXTILE FRAME ELEGANT BLACK

- IT**
  - Profilo sottile ma robusto da 22 mm
  - Sostituzione facile e veloce della grafica senza utensili
  - Scegliete il classico argento o l'elegante ed esclusivo colore nero
- ES**
  - Perfilera fina, elegante, única y de color negro de 22 mm
  - Se entrega montado
  - Idóneo en el sector de hostelería, tiendas minoristas u oficinas
- FR**
  - Fin profilé noir fin de 22 mm, élégant et unique
  - Livré monté
  - Idéal pour le secteur de l'hospitalité, les commerces de détail ou les bureaux



Art. nr.	DIN/Size	Dimensions (cm)			
		W	H	D	KG
TFR22WA2HBL	A2	42	59,4	2,2	0,7
TFR22WA1HBL	A1	59,4	84,1	2,2	1,5
TFR22WA0HBL	A0	84,1	118,9	2,2	2,2
TFR22W400x400HBL	400 x 400	40	40	2,2	0,6

- Other sizes are available on request
- Included: Wall hook

### DIGITAL FABRIC SHOP WINDOW

- IT**
  - Facile da spostare grazie alle rotelle nella base
  - Orientamento dello schermo facile da cambiare
  - Possibilità di personalizzare la struttura con una grafica in tessuto
- ES**
  - Fácil de desplazar gracias a las ruedas de la base
  - Fácil de cambiar la orientación de la pantalla
  - Personalice la carcasa con una impresión textil
- FR**
  - Facile à déplacer grâce aux roulettes intégrées au socle
  - Changement simple de l'orientation de l'écran
  - Personnalisez le boîtier avec un visuel en textile



Art. nr.	Dimensions (cm)			
	W	H	D	KG
Universal solution (without screen) DISHOPTFRUNI	67	188,1	61	33.3

- More Digital Displays see chapter 4 Digital Displays (p. 62)

### TEXTILE FRAME ELEGANT

- IT**
  - Profilo sottile ma solido da 22 mm
  - Profilo classico grazie al color argento
  - Cambio facile e veloce di grafiche senza bisogno di attrezzi
- ES**
  - Perfilera fina pero resistente
  - Perfilera de estilo clásico gracias al color plateado
  - Cambio de gráfica fácil y rápido sin necesidad de usar herramientas
- FR**
  - Profilé mince, mais solide de 22 mm
  - Profilé classique grâce à la couleur argentée
  - Changement sans outils, facile et rapide, du tissu imprimé



Art. nr.	DIN/Size	Dimensions (cm)			
		W	H	D	KG
TFR22WA1	A2	59,4	84,1	2,2	1,2
TFR22WA0	A0	84,1	118,9	2,2	1,9

- Other sizes are available on request
- Budget unassembled version





## OUR READY-TO-GO DESIGNS

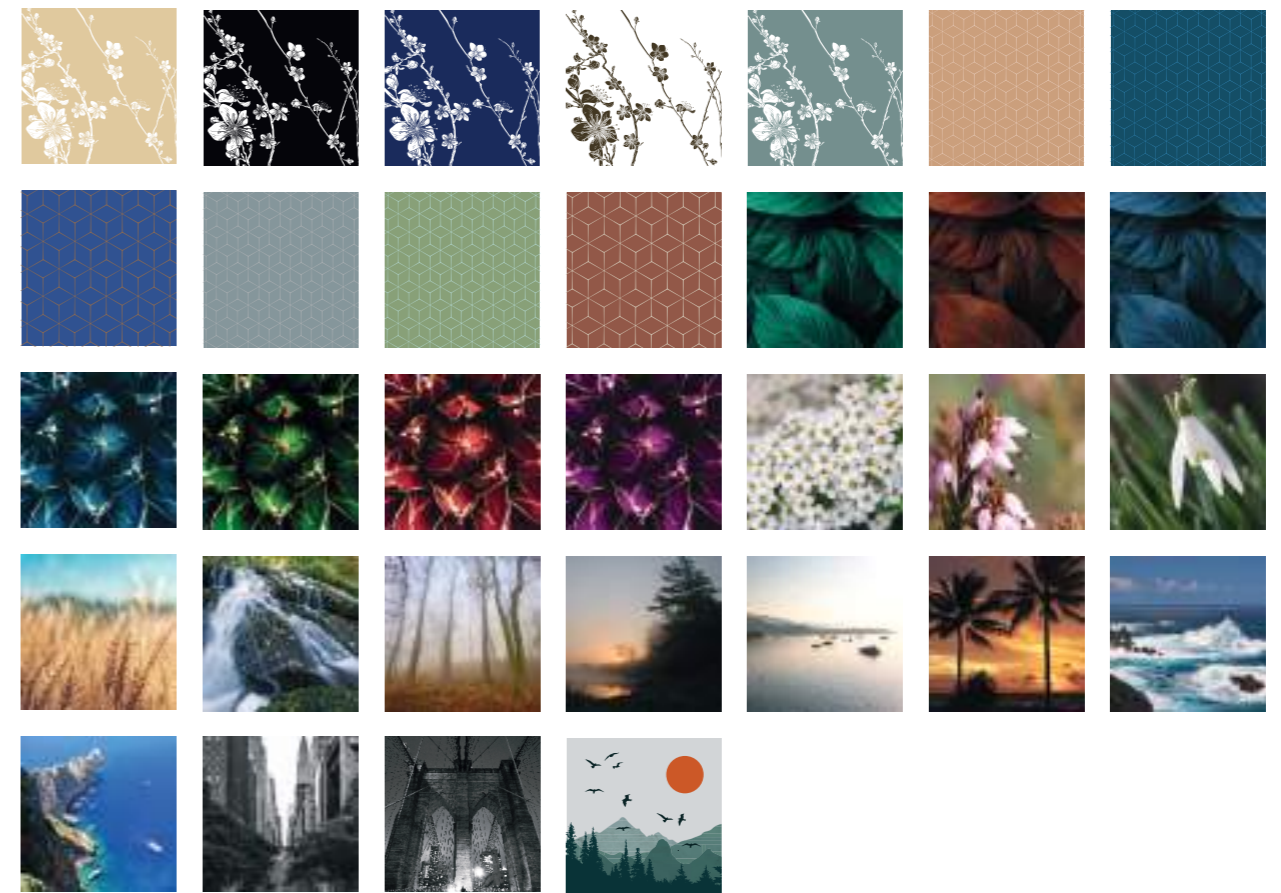

Choose your design

## STANDARD PRINT DESIGNS

Convenient and easy! A complete set of hardware, graphic and design. No need for a graphic designer - all the print designs are pre-made and ready to use. With just one click on your webshop, customers can order the display they need. We take care of the printing and drop shipping directly to your customers. The designs are versatile and suitable for various markets: Such as hospitality, retail, public spaces, offices and events.

Curious to all our Standard Print Designs for more various products?



CINEMA

CENTRAL  
CINEMA

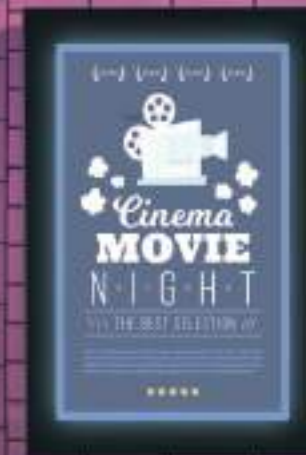

### 3. ILLUMINATED DISPLAYS

Espositori illuminati  
Tótems Publicitarios con Luz  
Displays Illuminés

Steal the show with an eye-catching bright illuminated display. Powerful LEDs increase visibility and make sure your brand and message shine. Various possibilities, from hanging to freestanding displays. Clear, visible, tool-free, quick and easy. Ideal to use at any point of sale or exhibitions and events.

#### INDEX

3.1 LED Poster Frames **50**  
Porta poster a LED  
Marcos para Póster LED  
Cadres LED pour Posters

3.2 Light Boxes & Illuminated Totems **54**  
Illuminated Totems  
Cassonetti e totem luminosi  
Caja de luz y Tótems Luminosos  
Caissons et Totems Lumineux

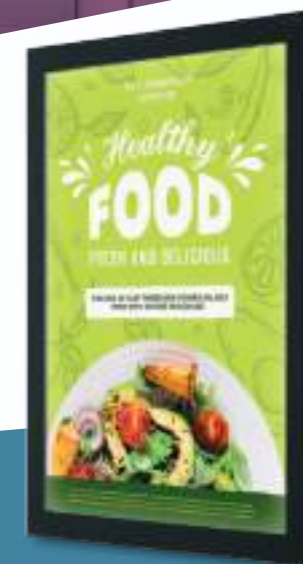

#### GOOD LED POSTER LIGHT BOX

- Perfect for shop window presentation
- Stunning illumination with 8 mm acrylic LED panel
- Minimal heat output, low running costs

#### BETTER LED MAGNETIC POSTER FRAME

- Smart magnetic frame, poster switch in seconds
- Elegant black magnetic frame
- Bright illumination with laser panel LED

#### BEST LED OUTDOOR PREMIUM POSTER CASE

- State of the art laser dot LED technology
- Premium safety glass cover
- Black ceramic printed glass for a stunning look

- GREAT LED ILLUMINATION 24/7
- EASY POSTER EXCHANGE WITH SNAP - TECHNIQUE
- ELEGANT LOOK, GREAT VARIETY OF DESIGNS AND SIZES

#### LED SLIDE IN FRAME SLIM

**BESTSELLER**

- IT**
- Design sottile e sofisticato
  - Cambio locandine rapido e semplice con scorrimento dall'alto
  - Promozione illuminata ideale adatta alle vetrine
- ES**
- Diseño fino y sofisticado
  - El cambio de poster fácil y rápido deslizándolo desde arriba
  - Promoción iluminada, ideal y adecuada para los escaparates de tiendas
- FR**
- Conception fine et sophistiquée
  - Changement rapide et facile de l'affiche en la faisant glisser depuis la partie supérieure
  - Promotion lumineuse idéale pour les vitrines des boutiques

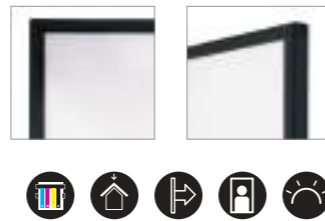

Art. nr.	DIN/Size	Dimensions (cm)			
		W	H	D	KG
SFSA3LED	A3	31,1	42,7	1	1,1
SFSA2LED	A2	43,5	60	1	2,1
SFSA1LED	A1	60,5	85	1	4,4



#### LED POSTER LIGHT BOX ECONOMY

- IT**
- Cornice a Scatto in alluminio leggera da 19 mm
  - Copertura locandina antiriflesso, stabile ai raggi UV
  - Temperatura del colore simile alla luce diurna 5000K
- ES**
- Ligero perfil de 19 mm de marco abatible de aluminio
  - Folio protector anti reflectante y resistente a rayos ultravioleta
  - Temperatura de color de luz diurna 5000K
- FR**
- Cadre en aluminium léger de 19 mm
  - Film pour poster anti-reflet, résistant aux UV
  - Température de couleur de jour 5000K



Art. nr.	DIN/Size	Dimensions (cm)			
		W	H	D	KG
PLEDEA3G19	A3	31,2	43,5	1,9	2
PLEDEA2G19	A2	43,5	60,9	1,9	4
PLEDEA1G19	A1	60,9	85,6	1,9	6
PLEDEA0G19	A0	85,6	51,5	1,9	10
PLEDE70x100G19	70 x 100	71,5	101,5	1,9	8



#### LED POSTER LIGHT BOX

**BESTSELLER**

- IT**
- Perfetta per presentazioni nelle vetrine
  - Illuminazione splendida con pannello acrilico LED da 8 mm
  - Minima emissione di calore, costi di gestione bassi
- ES**
- Perfecto para presentación en escaparate
  - Iluminación increíble con panel LED acrílico de 8 mm
  - Calentamiento mínimo, bajo consumo
- FR**
- Parfait pour la présentation en vitrine de magasin
  - Eclairage exceptionnel avec un panneau LED acrylique de 8 mm
  - Flux de chaleur minimal, faibles coûts de fonctionnement



Art. nr.	DIN/Size	Dimensions (cm)			
		W	H	D	KG
<b>Single-sided</b>					
PLEDA3G30	A3	33,9	46,2	2,7	2,5
PLEDA2G30	A2	46,2	63,6	2,7	4
PLEDA1G30	A1	63,6	88,3	2,7	7
PLEDA0G30	A0	88,3	123,1	2,7	11,4
PLED70x100G30	70 x 100	74,2	104,2	2,7	9

Art. nr.	DIN/Size	Dimensions (cm)			
		W	H	D	KG
<b>Double-sided</b>					
PLEDA1G30D	A1	63,9	88,6	3,3	8,9
PLEDA0G30D	A0	88,6	54,5	3,3	16,8
PLED70x100G30D	70 x 100	74,5	104,5	3,3	11,6

- Optional: Frame Hanging Kit for Double-sided version (see p. 61)
- Other colours and sizes on request



#### LED OUTDOOR PREMIUM POSTER CASE FREESTANDING

- IT**
- Autoportante e bifacciale
  - Illuminazione LED intensa 24/7
  - Profilo progettato per locandine standard o grafiche in tessuto in tensione
- ES**
- Independiente y de doble cara
  - Iluminación LED durante 24/7
  - Perfil diseñado para póster estándar o impresión de tela tensada
- FR**
- Détaché et double face
  - Éclairage LED lumineux 24/7
  - Profil conçu pour une impression d'affiche standard ou de tissu de tension



Art. nr.	DIN/Size	Dimensions (cm)			
		W	H	D	KG
SCEOS1200x1800DLED	120 x 180	138,4	240	22,3	145,1

- Other sizes and colours on request
- Electrical connection must be indoor or via IP rated electrical box
- 220V power cable must be prepared before installation





### LED OUTDOOR PREMIUM POSTER CASE

- IT**
  - Tecnologia punto laser LED all'avanguardia
  - Copertura in vetro di sicurezza Premium
  - Vetro stampato in ceramica nera per una resa sorprendente
- ES**
  - Tecnología LED
  - Cristal frontal templado Premium y de seguridad
  - Impresión en cerámica negra para un aspecto impresionante
- FR**
  - Technologie de pointe LED à point laser
  - Couverture en verre de sécurité de qualité
  - Imprimé en céramique noire pour un look exceptionnel



Art. nr.	DIN/Size	Dimensions (cm)			
		W	H	D	KG
SCEOSA1LED	A1	73,7	98,4	7	22,4
SCEOSA0LED	A0	98,4	133,2	7	30,8
SCEOS70x100LED	70 x 100	84,3	114,3	7	28,5

- Other sizes and colours available on request
- Waterproof IP56 certification for outdoor use
- Electrical connection must be indoor or via IP rated electrical box



### LED MAGNETIC POSTER FRAME

- IT**
  - Cornice magnetica elegante, cambio locandine in pochi secondi
  - Cornice magnetica nera elegante
  - Illuminazione intensa con pannello laser LED
- ES**
  - Marco magnético inteligente con cambio de gráfica en segundos
  - Elegante banda magnética de color negro
  - Illuminación clara con panel LED
- FR**
  - Cadre magnétique intelligent, changement de poster en quelques secondes
  - Cosse magnétique noire élégante
  - Eclairage lumineux avec panneau laser LED



Art. nr.	DIN/Size	Dimensions (cm)			
		W	H	D	KG
<b>Single-sided</b>					
PMLEDA2	A2	46,2	63,6	3	3,9
PMLEDA1	A1	63,6	88,3	3	6,8
PMLEDA0	A0	88,3	123,1	3	12
PMLED70x100	70 x 100	74,2	104,2	3	9

Art. nr.	DIN/Size	Dimensions (cm)			
		W	H	D	KG
<b>Double-sided</b>					
PMLEDA1D	A1	61,8	86,5	3	7,6

- Non-standard sizes on request



### FLEX TOWER

- IT**
  - Lampadina spot LED intensa da 15 Watt
  - Bacheca pieghevole con cornice solida in alluminio
  - Carrello imbottito con copertura per proteggere pannelli e grafiche
- ES**
  - LED brillante de 15 vatios
  - Vitrina plegable con estructura de aluminio sólido
  - Trolley para proteger paneles e impresiones
- FR**
  - Spot LED lumineux de 15 watts
  - Valise pliable avec cadre en aluminium solide
  - Trolley renforcé avec couvercle pour protéger les panneaux et les visuels

NEW: WITH PRINT

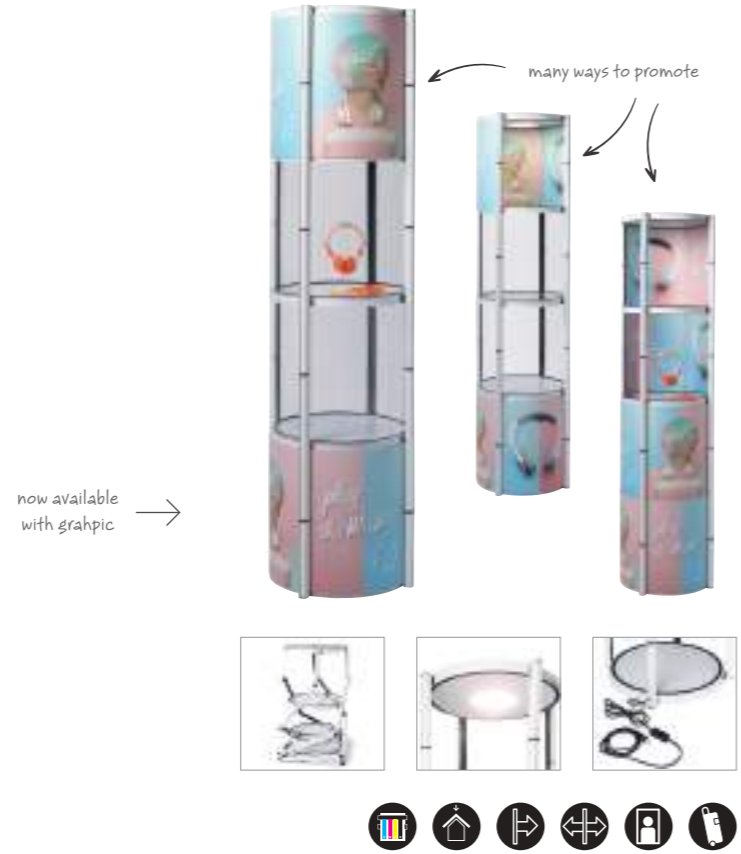

now available with graphic →

Art. nr.	Dimensions (cm)		
	W	H	KG
FLTWR	57	206	25,5

- Including 16 translucent PET Panels
- 24V LED Spot
- Optional: 8 extra PVC-free Panels for New Visuals (see p. 61)
- Perfect to combine with Flex Counter. See ch. 17 Counters and Table Covers (p. 263)

### ARCUATO® POSTER LIGHT COLUMN

- IT**
  - Speciale design ovale per un effetto LED eccezionale
  - Stabile grazie alla base in acciaio verniciato a polvere
  - Profilo cornice a clip per cambiare le locandine in modo semplice
- ES**
  - Diseño ovalado especial para buen efecto LED
  - Estable gracias a la base de acero esmaltada en polvo
  - Perfiles de marco abatible para el cambio de gráfica fácil
- FR**
  - Conception ovale spéciale pour un excellent effet de LED
  - Stable grâce à la base en acier thermolaqué
  - Profils de cadres clic-clac pour changement aisé du poster

BESTSELLER



Art. nr.	DIN/Size	Dimensions (cm)			
		W	H	D	KG
TL2XA1LED	2 x A1	64,1	169,7	35	23,3
TL2X70x100LED	2 x 70 x 200	74,7	201,5	42	35



easily create 90° corners with the connector



### BRIGHTBOX SINGLE

- IT**
  - L'alternativa luminosa agli striscioni standard
  - La soluzione Lightbox monofacciale più conveniente
  - Le luci LED sono integrate nella parte posteriore (Pellicola Block-Out)
- ES**
  - Una alternativa de banner estándar en versión iluminada
  - Solución económica de caja de luz a una cara
  - Las luces LED están integradas en la parte trasera (film de bloqueo)
- FR**
  - L'alternative lumineuse à la bannière standard
  - Une solution de caisson lumineux simple face économique
  - Les lumières LED sont intégrées dans le dos (film de blocage)

Art. nr.	DIN/Size	Dimensions (cm)			
		W	H	D	KG
BBOXS085-200	85 x 200	85	202	35	4,5
BBOXS100-200	100 x 200	100	202	35	5
BBOXS100-250	100 x 250	100	252	35	7,9

- Including Block-Out Film for Backside with integrated LED lights
- Including Padded Carry Bag
- Brightbox Connector (p. 61)
- Perfect to combine with Brightbox Counter. See ch. 17 Counters and Table Covers (p. 254)



BESTSELLER



BESTSELLER



## BRIGHTBOX DOUBLE

- IT**
- Lati magnetici collegabili con connettori in plastica per un montaggio perfetto
  - Installazione passo-passo rapida senza bisogno di attrezzi
  - Montaggio e sostituzione grafiche in tessuto semplici
- ES**
- Laterales magnéticos conectables con conectores de plástico para una fijación perfecta
  - Instalación rápida sin herramientas y paso a paso
  - Fácil fijación y reemplazo de la impresión de tela
- FR**
- Côtés magnétiques reliés entre eux par des connecteurs en plastique pour une fixation parfaite
  - Installation rapide sans outil et étape par étape
  - Fixation et remplacement faciles des visuels en tissu



Art. nr.	DIN/Size	Dimensions (cm)				KG
		W	H	D		
BBOXD100-200	100 x 200	100	201,5	40	6,9	
BBOXD100-250	100 x 250	100	251,5	40	9,9	
BBOXDBL100-200	100 x 200	100	201,5	40	6,9	

- Including Padded Carry Bag
- Brightbox Connector (p. 61)
- Perfect to combine with Brightbox Counter. See ch. 17 Counters and Table Covers (p. 254)



## BRIGHTBOX FOLD&GO

- IT**
- Allestimento semplice mediante srotolamento
  - Facile fissaggio e sostituzione della stampa su tessuto (SEG)
  - Telaio spesso da 85 mm
- ES**
- Se despliega sin esfuerzo
  - Fácil fijación y reemplazo de la impresión de tela (SEG)
  - Marco de 85 mm de grosor
- FR**
- Comptoir lumineux avec LED
  - Fixation et remplacement faciles des visuels en tissu (SEG)
  - Cadre de 85 mm d'épaisseur



Art. nr.	DIN/Size	Dimensions (cm)				KG
		W	H	D		
BBOXFOLDD100-200	100 x 200	100	202,5	40	9	

- Including Padded Carry Bag
- Double-sided illuminated banner
- Perfect to combine with Brightbox Fold&Go Counter. See ch. 17 Counters and Table Covers (p. 255)



NEW



## BRIGHTBOX PRO FLEX WALL

- IT**
  - Display illuminato stabile e ad alto impatto da 300 cm di altezza
  - Installazione rapida passo dopo passo senza attrezzi
  - Esposizione bifacciale
- ES**
  - Expositor iluminado estable e impresionante de 300 cm de altura
  - Instalación rápida sin herramientas y paso a paso
  - Exposición a doble cara
- FR**
  - Affichage lumineux stable et impressionnant de 300 cm de haut
  - Installation rapide sans outils et pas à pas
  - Exposition double face



Art. nr.	DIN/Size	Dimensions (cm)			
		W	H	D	KG
BBOXPFD100-300	100 x 300	100	301	45	20
BBOXPFD200-300	200 x 300	200	301	45	26
BBOXPFD300-300	300 x 300	300	301	45	30
BBOXPFD600-300	600 x 300	600	301	45	63

- Great addition to the Brightbox Family
- Perfect to combine with Brightbox Counter. See ch. 17 Counters and Table Covers (p. 254)

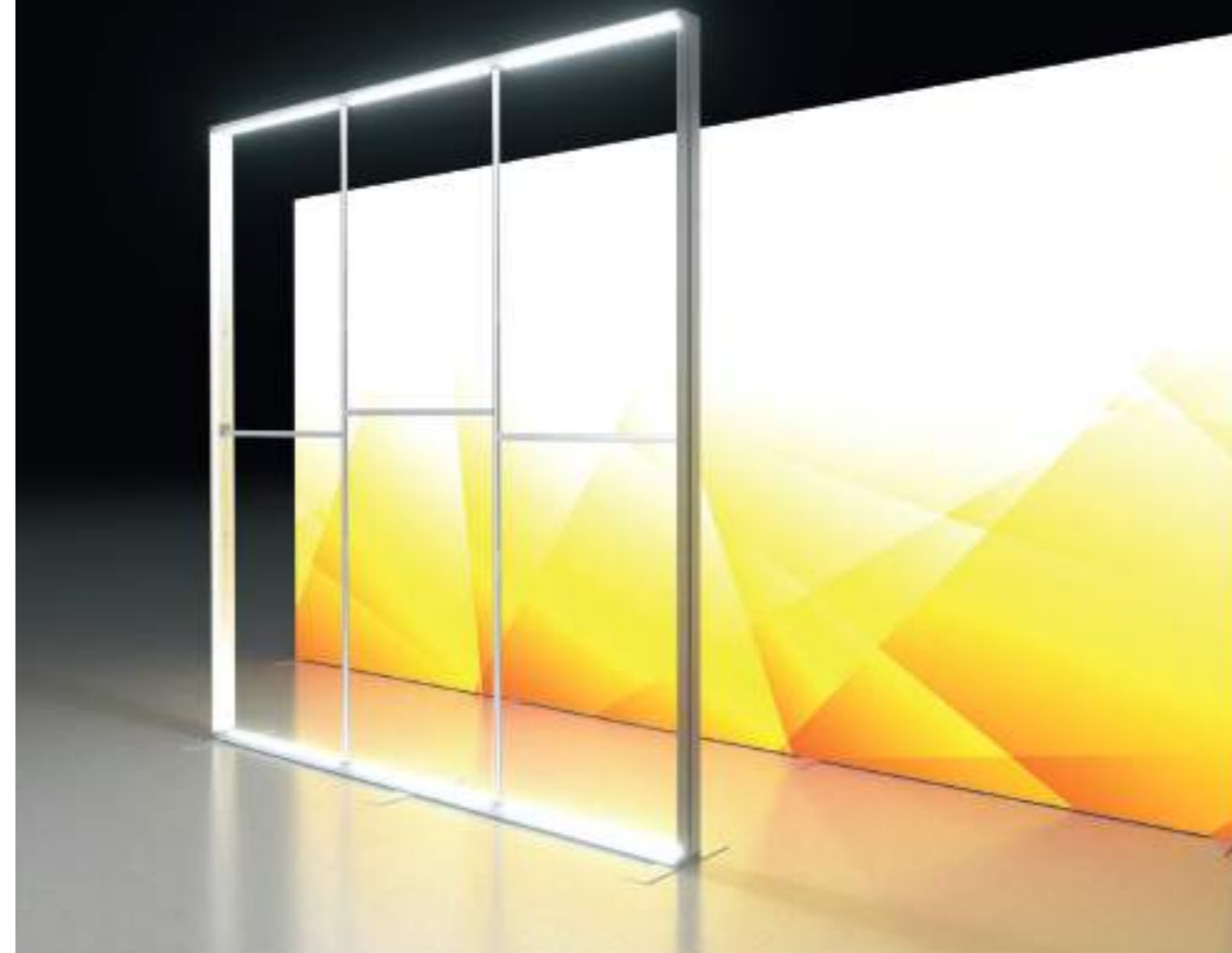

coming soon

BRIGHTBOX PRO FLEX ROOF

BRIGHTBOX PRO FLEX STORAGE SET



### FRAME HANGING KIT

Accessory for LED Poster Light Box



- IT** • Corda in metallo di alta qualità
- ES** • Cuerda de metal de alta calidad
- FR** • Câble métallique de qualité supérieure

Art. nr. APPCL

### PERSONALISED HIPS BOARD GRAPHICS

Accessory for Flex Tower and Flex Counter



- IT** • Set di 8 pannelli stampati, PVC free
- ES** • Set mit 8 bedruckten, PVC-freien Paneel-Prints
- FR** • Ensemble de 8 visuels imprimés sur panneaux sans PVC

Art. nr. FLP-SETPRINT-HW1

### BRIGHTBOX CONNECTOR

Accessory for Brightbox Single and Brightbox Double



- IT** • Unione di due pareti brightbox posizionate a 90 gradi
- ES** • Vincule dos paredes Brightbox en un ángulo de 90 grados
- FR** • Reliez deux murs Brightbox ensemble dans un angle de 90 degrés

Art. nr. BBOX-CC

🔗 Suitable for Brightbox Single and Double

Brightbox XL (p. 60/ch. 3)

## BRIGHTBOX XL

- IT** • Perfetto per esposizioni promozionali a breve termine  
• Montaggio e sostituzione grafiche in tessuto semplici (SEG)  
• Alternativa economica a Pop-Up Impress
- ES** • Perfecto para promociones cortas durante las ferias  
• Fácil colocación y cambio de gráfica de tela (SEG)  
• Una alternativa asequible para Pop-Up Impress
- FR** • Parfait pour les promotions à court terme lors des expositions  
• Fixation et remplacement faciles des visuels en tissu (SEG)  
• Une alternative économique pour Pop-Up Impress



Art. nr.	DIN/Size	Dimensions (cm)			
		W	H	D	KG
BBOXXL300-240	300 x 240	242	300,3	41,9	21,4

- 🔗 Great addition to the Brightbox Family
- 🔗 Perfect to combine with Brightbox Counter.  
See ch. 17 Counters and Table Covers (p. 254)



60 🔗 6500 K colour temperature and Edge lit 24V LED Lights

🔗 Graphic available



## 4. DIGITAL DISPLAYS

Espositori Digitali  
Pantallas Digitales  
Afficheurs Digitales

Digital Displays offer dynamic content and real-time advertising solutions to engage customers. The professional displays provide ultra-high definition, crystal clear picture quality designed for 24/7 use. The portfolio includes indoor and outdoor Digital Totems, A-Boards, Kiosks, Wall & Hanging Panels in various sizes and colours as well as tablet holders.

- THE LATEST PROFESSIONAL QMC SAMSUNG SCREENS
- CLEAR MESSAGE AND INTERACTIVITY 24/7/365 OPERATIONAL
- USB DRIVE SOCKET, ETHERNET CONNECTION, WI-FI CONNECTIVITY

### INDEX

4.1 Digital Displays <i>Espositori Digitali Pantallas Digitales Afficheurs Digitales</i>	66
4.2 Screen Holders and Tablet Holders <i>Supporti per schermi e tablet Soportes para Pantallas y Tablets Supports pour écrans et tablettes</i>	82

### GOOD SMART LINE DIGITAL TOTEM

- Elegant frameless design
- Housing standard available in black or white
- Heavy base 8 mm steel plate ensuring good stability

### BETTER SMART LINE DIGITAL TOTEM RACK

- Integrated brochure rack to hold 6 x A4 printed advertising
- Fingerprint resistant paint finish
- Housing standard available in black and white

### BEST SMART LINE DIGITAL TOTEM DOUBLE-SIDED

- Two screens for double exposure
- Synchronise or show different moving content on both sides
- Elegant frameless design



## 'DIGITAL IS THE FUTURE'

A picture is worth more than a thousand words. Let's go for more! With the Digital Display products you attract attention, tell stories and create an unforgettable impression at the right place and time. Easy, practical and extensible: those are the three keywords for the Digital Display assortment. Your wishes will be fulfilled as the Digital Displays are customisable to your requested size and preferences. Spread your message elegantly and durable.

## ADAPT TO THE MOMENT

Change your message easily at any time of the day. Whether it's in the morning or during weekends, when it's raining or the sun is shining. You name it. Your message will always suit the situation. Speed won't be a problem: play your images and videos easily via Plug & Play with the USB drive, share via Wi-Fi or upgrade with Content Management System MagicINFO Cloud.

## STAY IN TOUCH

Give the best and get the best: create interaction with your public. Show your e-shop, receive feedback on the spot or promote other items. It's all up to you. The displays have a safety tempered glass or plastic cover and have a heavy duty aluminium or steel construction.

## EVERYWHERE AT ANY TIME

The Digital Displays are equipped with the latest professional QMC Samsung screens. There is no need to worry about missing your moment to shine, because the displays are operational 24/7, all year long. Even with the outdoor displays, you don't have to miss anything.

## MEET ANY DIGITAL DESIRE

With our European in-house production centre, we can produce the Digital Display your customers are looking for. Need a different colour, size or just the housing? No worries! Our own R&D and production team have got you covered! We are all geared up to provide you and your customer the perfect, digital solution!



## DIGITAL TOTEM SKY GO

- IT**
- Totem leggero con base rimovibile
  - Design innovativo che consente un rapido montaggio in loco
  - Imballaggio compatto, ideale per il trasporto in auto
- ES**
- Tótem ligero con base desmontable
  - Diseño innovador que permite montaje rápido in situ
  - Embalaje compacto apto para transporte en coche
- FR**
- Totem léger avec base amovible
  - Conception innovante permettant un montage rapide sur site
  - Emballage compact compatible avec le transport en voiture



Art. nr.	Inch	Dimensions (cm)			
		W	H	D	KG
DISKYTOTEMGO43ESF	43"	65,2	180,5	45,2	27,7

- Optional: Reusable steel panel with optional branding on request (see p. 81)
- Screen is not covered with glass

- Simply upload content via USB or Wi-Fi or use optional Samsung Content Management Software



### DIGITAL TOTEM SKY

- IT**
  - Design elegante, snello e open frame
  - Verniciatura resistente alle impronte delle dita
  - Porte facilmente accessibili protette da un coperchio in acciaio
- ES**
  - Diseño de marco abierto fino y elegante
  - Acabado en pintura resistente a huellas dactilares
  - Puertos de fácil acceso protegidos por una tapa de acero
- FR**
  - Conception du cadre élégante, mince et ouverte
  - Peinture résistante aux empreintes digitales
  - Ports facilement accessibles et protégés par un couvercle en acier



Art. nr.	Inch	Dimensions (cm)			
		W	H	D	KG
DISKYTOTEM43ESF	43"	60,3	190	60	33,2
DISKYTOTEM55ESF	55"	75,3	205,2	60	47,8

Screen is not covered with glass



### SMART LINE DIGITAL TOTEM DOUBLE-SIDED

- IT**
  - Due schermi per una doppia esposizione
  - Sincronizzate o mostrate diversi contenuti in movimento su entrambi i lati
  - Elegante design privo di cornice
- ES**
  - Dos pantallas para doble exposición
  - Sincronice o muestre diferentes contenidos en movimiento en ambos lados
  - Elegante diseño sin marco
- FR**
  - Double écran pour double affichage
  - Synchronisez ou diffusez différents contenus animés des deux côtés
  - Design élégant sans cadre



Art. nr.	Inch	Dimensions (cm)			
		W	H	D	KG
DITDTOTEM43ESF	43"	57,5	182,2	53	74,3
DITDTOTEM50ESF	50"	66,2	188,8	53	85
DITDTOTEM43C9003ESF	43"	57,5	182,2	53	74,3
DITDTOTEM50C9003ESF	50"	66,2	188,8	53	85

Screen is not covered with glass  
Housing standard available in black and white



### STREAMLINE DIGITAL TOTEM

- IT**
  - La base è una piastra in acciaio pesante da 6 mm
  - Design elegante con uno spessore del profilo di 25 mm
  - Verniciatura resistente alle impronte delle dita
- ES**
  - Base de placa de acero pesado de 6 mm
  - Diseño elegante con un perfil de 25 mm grosor
  - Acabado en pintura resistente a huellas dactilares
- FR**
  - Socle en acier lourd de 6 mm
  - Conception élégante avec une épaisseur de profil de 25 mm
  - Peinture résistante aux empreintes digitales

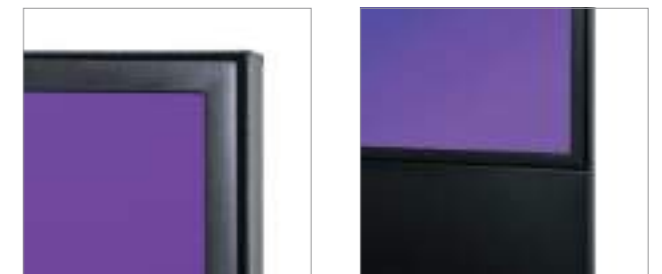

Art. nr.	Inch	Dimensions (cm)			
		W	H	D	KG
DITOTEMSTREAM43ESF	43"	56,6	126,1	47	22

Branding of the totem housing on request  
Screen is not covered with glass



NEW: BLACK COLOUR

BESTSELLER



## DIGITAL SLIM TOTEM

- IT**
- Design classico del Totem digitale
  - Vetro di sicurezza per la protezione dello schermo
  - Possibilità di installare la base senza che sia visibile
- ES**
- Diseño clásico de tótem digital
  - Cristal de seguridad templado para proteger la pantalla
  - Posibilidad de montar la base de forma invisible en el suelo
- FR**
- Design classique du Totem numérique
  - Verre de sécurité trempé pour protéger l'écran
  - La base peut être fixée au sol en toute discrétion

Art. nr.	Inch	Dimensions (cm)			KG	
		W	H	D		
DISTOTEMBL43ESF	43"	71,9	202	50	85	NEW
DISTOTEMBL50ESF	50"	78,9	202	70	97,8	NEW
DISTOTEMBL55ESF	55"	87,3	202	70	108,1	NEW
DISTOTEMBL65ESF	65"	105,7	222	80	147,9	NEW
DISTOTEM43ESF	43"	71,9	202	50	85	
DISTOTEM50ESF	50"	78,9	202	70	97,8	
DISTOTEM55ESF	55"	87,3	202	70	108,1	
DISTOTEM65ESF	65"	105,7	222	80	147,9	

**With Touch Functionality**

DISTOTEMBL43ESFT	43"	71,9	202	50	86	NEW
DISTOTEMBL50ESFT	50"	78,9	202	70	99	NEW
DISTOTEMBL55ESFT	55"	87,3	202	70	109	NEW
DISTOTEMBL65ESFT	65"	105,7	222	80	148,9	NEW
DISTOTEM43ESFT	43"	71,9	202	50	86	
DISTOTEM50ESFT	50"	78,9	202	70	99	
DISTOTEM55ESFT	55"	87,3	202	70	109	
DISTOTEM65ESFT	65"	105,7	222	80	148,9	

- Standard colour black, other RAL colours on request
- Optional: Touch foil can be applied to provide touch functionality
- Only 70 mm deep totem



## SMART LINE DIGITAL TOTEM

- IT**
- Design elegante e senza cornice
  - Struttura standard disponibile in bianco e nero
  - Base robusta in acciaio da 8 mm per una buona stabilità
- ES**
- Elegante diseño sin marco
  - Carcasa estándar disponible en blanco o negro
  - Base pesada de chapa de acero de 8 mm que garantiza una buena estabilidad
- FR**
- Design élégant sans cadre
  - Boîtier de base disponible en noir ou en blanc
  - Base lourde en tôle d'acier de 8 mm pour une bonne stabilité



Art. nr.	Inch	Dimensions (cm)			KG
		W	H	D	
DITTOTEM43ESF	43"	57,5	181,3	46	55
DITTOTEM55ESF	55"	72,5	200,1	52	88
DITTOTEM43C9003ESF	43"	57,5	181,3	46	55
DITTOTEM55C9003ESF	55"	72,5	200,1	52	88

- Standard colour black or white, other RAL colours on request
- Branding of the totem housing on request
- Screen is not covered with glass

Simply upload content via USB or Wi-Fi or use optional Samsung Content Management Software

### SMART LINE DIGITAL TOTEM RACK

- IT**
  - Portadepliant integrato per contenere stampati pubblicitari 6 x A4
  - Verniciatura resistente alle impronte delle dita
  - Struttura standard disponibile in nero e in bianco
- ES**
  - Estante para folletos integrado para contener 6 materiales publicitarios impresos en formato A4
  - Acabado en pintura resistente a huellas dactilares
  - Carcasa estándar disponible en blanco o negro
- FR**
  - Le porte-brochures intégré peut contenir 6 publicités imprimées au format A4
  - Peinture résistante aux empreintes digitales
  - Boîtier de base disponible en noir ou en blanc



Art. nr.	Inch	Dimensions (cm)			
		W	H	D	KG
DITTOTEMR43ESF	43"	57,5	181,3	46	57
DITTOTEMR43C9003ESF	43"	57,5	181,3	46	57
<b>With Touch Functionality</b>					
DITTOTEMR43ESFT	43"	60,2	181,9	46	61,5
DITTOTEMR43C9003ESFT	43"	60,2	181,9	46	61,5

- Standard colour black or white, other RAL colours on request
- Branding of the totem housing on request
- Screen is not covered with glass



### OUTDOOR DIGITAL TOTEM

- IT**
  - Adatto ad un uso esterno da -30°C a 50°C grazie alle sue ventole di raffreddamento
  - Resistente alle intemperie grazie alla certificazione IP56
  - Installazione fissa in calcestruzzo necessaria
- ES**
  - Totalmente a prueba de uso en exteriores de -30°C a 50°C gracias a los ventiladores de refrigeración
  - Resistencia a la intemperie gracias a la certificación IP56
  - Requiere instalación fija en hormigón
- FR**
  - Résistance complète en extérieur de -30°C à 50°C grâce à des ventilateurs pour le refroidissement
  - Résistance aux intempéries grâce à la certification IP56
  - Installation fixe sur béton nécessaire

Art. nr.	Inch	Dimensions (cm)			
		W	H	D	KG
DIOTOTEM55ESF	55"	85,3	200,9	21	146,1

- With ground fixing plate and electrical connection
- Inox front and back metal sheets
- Outdoor display is without WiFi connection

• Simply upload content via USB or use optional Samsung Content Management Software



### DIGITAL FABRIC SHOP WINDOW

- IT**
  - Facile da spostare grazie alle rotelle nella base
  - Orientamento dello schermo facile da cambiare
  - Possibilità di personalizzare la struttura con una grafica in tessuto
- ES**
  - Fácil de desplazar gracias a las ruedas de la base
  - Fácil de cambiar la orientación de la pantalla
  - Personalice la carcasa con una impresión textil
- FR**
  - Facile à déplacer grâce aux roulettes intégrées au socle
  - Changement simple de l'orientation de l'écran
  - Personnalisez le boîtier avec un visuel en textile



Art. nr.	Dimensions (cm)			
<b>Universal solution (without screen)</b>	<b>W</b>	<b>H</b>	<b>D</b>	<b>KG</b>
DISHOPTFRUNI	67	188,1	61	33,3

- ⓘ Screen not included
- More Fabric (SEG) systems see chapter 2 Textile Frames (p. 42)

### DIGITAL SHOP WINDOW DISPLAY

- IT**
  - Design elegante e senza cornice
  - Montaggio a parete facile
  - Adatta sia per orientamento verticale che orizzontale
- ES**
  - Elegante diseño sin marco
  - Fácil montaje en pared
  - Apto tanto para orientación vertical como horizontal
- FR**
  - Design élégant sans cadre
  - Montage mural facile
  - Peut être utilisé à la fois en orientation portrait et paysage



Art. nr.	Dimensions (cm)			
<b>Universal solution (without screen)</b>	<b>W</b>	<b>H</b>	<b>D</b>	<b>KG</b>
DISHOPUNI	80	180	50	45,5

- ⓘ Screen not included

### DIGITAL COUNTERTOP NOVA

NEW

- IT**
  - Espositore digitale da banco con schermo Samsung UHD da 13" in orientamento verticale
  - Compatto e portatile (3,6 kg, altezza 32 cm)
  - Perfetto per banchetti da reception, punti vendita e aree di servizio
- ES**
  - Pantalla digital de sobremesa con pantalla Samsung UHD de 13" en orientación vertical
  - Compacta y portátil (3,6 kg, altura 32 cm)
  - Perfecta para recepciones, mostradores de tiendas y áreas de servicio
- FR**
  - Totem numérique de comptoir avec écran Samsung UHD 13" en orientation portrait
  - Compact et portable (3,6 kg, hauteur 32 cm)
  - Idéal pour les comptoirs d'accueil, points de vente et zones de service



Art. nr.	Inch	Dimensions (cm)			
		<b>W</b>	<b>H</b>	<b>D</b>	<b>KG</b>
DINOVAC13ESF	13"	20,4	32	13	2,7

### SMART LINE DIGITAL PANEL

BESTSELLER

- IT**
  - Disponibile con o senza schermo digitale
  - Orientamento dello schermo facile da cambiare
  - Lato posteriore liscio con ventilazione
- ES**
  - Elija con o sin pantalla digital
  - Fácil de cambiar la orientación de la pantalla
  - Parte trasera con acabado liso y ventilación
- FR**
  - Au choix, avec ou sans écran numérique
  - Changement facile de l'orientation de l'écran
  - Face arrière lisse et ventilée

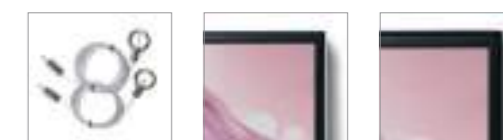

Art. nr.	Inch	Dimensions (cm)			
		<b>W</b>	<b>H</b>	<b>D</b>	<b>KG</b>
DITWALL43ESF	● 43"	56,5	97,6	7,4	20
DITWALL50ESF	● 50"	65,2	113	7,8	27
DITWALL43C9003ESF	○ 43"	56,5	97,6	7,4	20
DITWALL50C9003ESF	○ 50"	65,2	113	7,8	27

- Standard colour black or white, other RAL colours on request
- Optional: Possibility for hanging on ceiling with the Suspension Set (see p. 81)

- Simply upload content via USB or use optional Samsung Content Management Software

SMART LINE DIGITAL A-BOARD

BESTSELLER

- IT**
  - Trasporto e spostamenti facili grazie alle ruote
  - Design elegante senza cornice
  - Ideale per eventi, showroom, ospitalità e POS
- ES**
  - Fácil de transportar y desplazar con ruedas
  - Elegante diseño sin marco
  - Perfecto para eventos, salas de exposiciones, hostelería y puntos de venta
- FR**
  - Facile à transporter et à déplacer grâce aux roulettes
  - Design élégant sans cadre
  - Idéal pour les événements, les showrooms, l'hôtellerie et la PLV

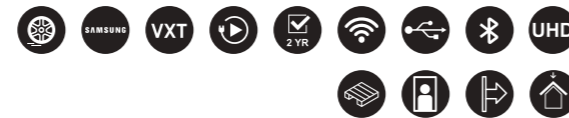

Art. nr.	Inch	Dimensions (cm)			
		W	H	D	KG
DIAT43ESF	43"	56	123,8	42,6	32
DIAT43C9003ESF	43"	56	123,8	42,6	32

- Optional: Smart Line Digital A-Board Trolley Case (see p. 81)
- Standard colour black or white, other RAL colours on request
- Branding of the A-Board housing on request
- Wheels included for easy transport



DIGITAL A-BOARD SPECTRUM

- IT**
  - Schermo comodamente posizionato ad altezza occhi
  - Facile da trasportare e spostare grazie alle rotelle
  - Verniciatura resistente alle impronte delle dita
- ES**
  - Pantalla ubicada de forma cómoda a la altura de los ojos
  - Fácil de transportar y desplazar con ruedas
  - Acabado en pintura resistente a huellas dactilares
- FR**
  - Écran positionné de façon pratique, à hauteur de regard
  - Facile à transporter et à déplacer grâce aux roulettes
  - Peinture résistante aux empreintes digitales



Art. nr.	Inch	Dimensions (cm)			
		W	H	D	KG
DIAS43ESF	43"	56,4	158,7	46,1	23,5
DIAS43C9003ESF	43"	56,4	158,7	46,1	23,5

- Perfect for events, showrooms, hospitality and POS
- Simply upload content via USB or Wi-Fi or use optional Samsung Content Management Software





## STREAMLINE DIGITAL A-BOARD

- IT**
- Efficiente e semplice da piegare per trasportarlo con facilità
  - Design elegante con uno spessore del profilo di 25 mm
  - Ideale per gli showroom, l'ospitalità e altri usi interni
- ES**
- Plegado eficiente y fácil para un transporte sencillo
  - Diseño elegante con un perfil de 25 mm grosor
  - Perfecto para eventos, salas de exposiciones, hostelería y puntos de venta
- FR**
- Efficace et facile à plier pour un transport aisé
  - Conception élégante avec une épaisseur de profil de 25 mm
  - Idéal pour les événements, les showrooms, l'hôtellerie et la PLV



Art. nr.	Inch	Dimensions (cm)			
		W	H	D	KG
DIASTREAM43ESF	43"	47	126,1	56,6	22

⊕ Fingerprint resistant paint finish



## STREAMLINE DIGITAL KIOSK

- IT**
- Inclinazione a 30 gradi per una facile lettura dei contenuti
  - Design elegante con uno spessore del profilo di 25 mm
  - Con funzionalità touch
- ES**
- Ángulo de 30 grados para facilitar la lectura del contenido
  - Diseño elegante con un perfil de 25 mm grosor
  - Avec fonctionnalité tactile
- FR**
- Inclinaison de 30 degrés facilitant la lecture du contenu
  - Conception élégante avec une épaisseur de profil de 25 mm
  - Avec fonctionnalité tactile



Art. nr.	Inch	Dimensions (cm)			
		W	H	D	KG
DIKIOSKSTREAM32ESFT	32"	60	130	74,5	35,5

⊕ Fingerprint resistant paint finish



GET THE FULL EXPERIENCE AND GO TO [WWW.DIGITAL-COUNTER.COM](http://WWW.DIGITAL-COUNTER.COM)

**BESTSELLER**



## DIGITAL COUNTER FUTURO

- IT**
  - Comptoir premium avec affichage digital en orientation paysage ou portrait
  - Assemblage facile
  - Modèle standard avec visuels noirs latéraux (SEG)
- ES**
  - Mostrador premium con presentación digital en orientación horizontal
  - Fácil de montar
  - De serie con gráficos negros en los laterales (SEG)
- FR**
  - Comptoir premium avec affichage numérique en orientation paysage
  - Assemblage facile
  - Modèle standard avec visuels noirs latéraux (SEG)



Art. nr.	Icon	Inch	Dimensions (cm)			
			W	H	D	KG
DICOUNTER32ESF	Portrait	32"	72	92,8	44,5	23,1
DICOUNTER55ESF	Landscape	55"	92,8	134,5	40,5	45,5
DICOUNTER32C9003ESF	Portrait	32"	72	92,8	44,5	23,1



### SUSPENSION SET

Accessory for Smart Line Digital Panel



- IT**
  - Kit di montaggio certificato TÜV per sospensione da soffitto
- ES**
  - Set de suspensión para suspensión de techo con certificado TÜV
- FR**
  - Kit de suspension pour suspension au plafond certifié TÜV

Art. nr. DITWALLHS

### SKY TOTEM GO COVER

Accessory for Digital Sky Go Totem



- IT**
  - Pannello in acciaio riutilizzabile per promozioni future
- ES**
  - Panel de acero reutilizable para promociones futuras
- FR**
  - Panneau en acier réutilisable pour vos futures campagnes

Art. nr. SKYTOTEMCOVER

### SMART LINE DIGITAL A-BOARD TROLLEY CASE

Accessory for Smart Line Digital A-Board



- IT**
  - ???
- ES**
  - Asas en la parte superior y en los laterales para facilitar el levantamiento y transporte
- FR**
  - Poignées sur le dessus et les côtés pour une prise en main facile

Art. nr. DIAT43-TC



### VESA MOUNT FREESTANDING

- IT**
- Supporto per monitor VESA universale fino a 22"
  - Piastra di fissaggio VESA universale per espositori multimediali e schermi
  - Inclinazione regolabile
- ES**
- Para monitores hasta 22"
  - Sujeción VESA universal para pantallas y displays multimedia
  - Posición de inclinación ajustable
- FR**
- Support de moniteur VESA universel jusqu'à 22"
  - Plaque de fixation VESA universelle pour écrans et affichages multimédia
  - Inclinaison réglable



Art. nr.	⚙	Dimensions (cm)			
		W	H	D	KG
DSVESA	●	45	117	45	13,5

📌 Screen not included

### TRIGRIP FREESTANDING TELESCOPIC

- IT**
- Altezza regolabile da 740 mm a 1300 mm
  - Ottima stabilità
  - Adatto a serratura Kensington
- ES**
- Altura regulable desde 740 mm hasta 1300 mm
  - Buena estabilidad
  - Listo para cerradura Kensington
- FR**
- Hauteur réglable de 740 mm à 1300 mm
  - Excellente stabilité
  - Prêt pour le verrouillage Kensington



Art. nr.	⚙	Inch	Dimensions (cm)			
			W	H	D	KG
DTSTGT10	●	10"	33	107	33	6,7
DTSTGT13	●	13"	33	110	33	6,7

📌 Device not included

### TRIGRIP STAND STEEL

- IT**
- Supporto tablet con design Premium e struttura in acciaio
  - Orientabile sia in verticale sia in orizzontale
  - Con serratura
- ES**
- Un soporte para tablet con el diseño premium y con la construcción de acero
  - Orientación horizontal y vertical
  - Con el cierre
- FR**
- Support pour tablette de qualité supérieure avec structure en acier
  - Pour orientation portrait et paysage
  - Verrouillable



Art. nr.	⚙	Inch	Dimensions (cm)			
			W	H	D	KG
DTSTGL10	●	10"	30	115	30	6

📌 Steel frame suitable for branding with screen printing or adhesive foil





# SAMSUNG

## BENEFITS OF DIGITAL DISPLAYS

- ✦ Flexible advertising, change your content anytime you want
- ✦ Draw attention with Samsung's high resolution screens boasting vibrant colours
- ✦ Save time and resources, manage and update content remotely
- ✦ Cost efficiency on the long run
- ✦ 2 years of warranty
- ✦ Plug & Play your content easily to every digital
- ✦ Option to add 24/7 Samsung support into MagicINFO Cloud
- ✦ Communicate quickly and increase audience engagement
- ✦ Suitable for various environments like retail, hospitality, events and public spaces
- ✦ European production



## 5. PAVEMENT SIGNS

Espositori per marciapiedi  
Señales de Pavimento  
Chevalets de Trottoir

Pavement signs are the most common and effective advertising method to get people to notice your business. At the entrance of your store, restaurant or other public place. A-Boards and Windtalkers are commonly used in pedestrian and high traffic areas. Easy to set up and available in a wide variety of styles, shapes, materials and sizes.



### INDEX

5.1 A-Boards Cavalletti Caballete Publicitario Stop-Trottoir	88
5.2 Windtalkers Windtalkers Paneles Involcables Exterior Stop-Trottoir	102

- GOOD STABILITY DUE TO ALUMINIUM FEET OR FILLABLE BASE
- INDOOR, OUTDOOR AND HEAVY WEATHER RESISTANT OPTIONS
- EASY POSTER EXCHANGE WITH SNAP - TECHNIQUE



### ✓ GOOD 32 MM PROFILE A-BOARD

- Best selling outdoor pavement sign
- Stable metal back wall
- UV resistant anti-glare protection foil



### 👍 BETTER DESIGN COMPASSO® A-BOARD

- Unique 37 mm aluminium double profile
- Premium design with the curved top frame
- Special designed foil for poster protection



### 🏆 BEST DESIGN A-BOARD PRIME

- High quality A-Board with special safety features
- Safety catch folding mechanism
- Non corrosive metal back panel

### 32 MM PROFILE A-BOARD

**BESTSELLER**

- IT**
  - L'espositore a cavalletto per esterni più venduto
  - Stabile parete posteriore in metallo
  - Pellicola protettiva antiriflesso resistente ai raggi UV
- ES**
  - El caballete publicitario de suelo más vendido
  - Trasera metálica y estable
  - Folio protector antirreflejos y contra rayos ultravioleta
- FR**
  - Stop trottoir extérieur le plus vendu
  - Panneau arrière stable en métal
  - Film de protection antireflet résistant aux UV



Art. nr.	DIN/Size	Dimensions (cm)			
		W	H	D	KG
<b>Mitred corners</b>					
ZPA2G32ME	A2	46,5	99,9	68,3	4,5
ZPA1G32ME	A1	63,9	109,4	74,4	9,2
ZPA0G32ME	A0	88,6	138	92,5	15,4
ZP50x70G32ME	50x70	54,5	99,9	74,4	6,6
ZP70x100G32ME	70x100	92,5	138	74,5	10,7
ZPA1G32MEC9005	A1	63,9	109,4	74,4	9,2
ZP50x70G32MEC9005	50x70	54,5	99,9	74,4	6,6
ZP70x100G32MEC9005	70x100	92,5	138	74,4	10,7
<b>Rounded corners</b>					
ZPA2R32ME	A2	46,5	102,5	68,3	5,8
ZPA1R32ME	A1	63,9	112	74,4	8,7
ZPA0R32ME	A0	88,6	140,6	92,5	15,1
ZP50x70R32ME	50x70	54,5	112	74,4	6,4
ZP70x100R32ME	70x100	74,5	140,6	92,5	10,2



Optional: Topcard + Wireframe Set for size A1 and Brochure Basket (see p. 100)

### 32 MM PROFILE WEATHER RESISTANT A-BOARD

- IT**
  - Per un utilizzo esterno
  - Fori di drenaggio sul profilo inferiore
  - Tasca completamente sigillata (antispruzzo) resistente alle intemperie
- ES**
  - Para uso en exteriores
  - Marco inferior con orificios como sistema de desagüe
  - Bolsa para póster totalmente sellada resistente a la intemperie (a prueba de salpicaduras)
- FR**
  - Pour l'extérieur
  - Trous de drainage dans le profil inférieur
  - Sac pour affiche entièrement scellé résistant aux intempéries (éclaboussures)



Art. nr.	DIN/Size	Dimensions (cm)			
		W	H	D	KG
ZPA2R32MEWR	A2	46,5	102,5	68,3	8,9
ZPA1R32MEWR	A1	63,9	112	74,4	11,1
ZP50x70R32MEWR	50x70	54,5	112	68,3	8,4
ZP70x100R32MEWR	70x100	68,3	140,6	74,5	13,5



See accessory page for options (p. 100)

Graphic available

### DESIGN COMPASSO® A-BOARD

- IT**
  - Profilo doppio in alluminio da 37 mm unico
  - Design premium con cornice superiore curva
  - Progettato appositamente per la protezione delle coperture delle locandine
- ES**
  - Doble marco especial de aluminio de 37 mm
  - Diseño excepcional de marco superior curvado
  - Folio protector diseñado especialmente para mejor protección
- FR**
  - Profil double en aluminium unique de 37 mm
  - Conception haut de gamme avec cadre supérieur incurvé
  - Film spécialement conçu pour la protection des posters



Art. nr.	DIN/Size	Dimensions (cm)			
		W	H	D	KG
ZPC2A1	A1	66	115	78	16,4

Optional: 3 mm foamed PVC Topcard and Brochure Basket suitable for Compasso® (see p. 101)

### DESIGN A-BOARD PRIME

**PATENTED**

- IT**
  - Cavalletto di alta qualità con particolari caratteristiche di sicurezza
  - Meccanismo di chiusura di sicurezza
  - Pannello posteriore in metallo non corrosivo
- ES**
  - Caballete de alta calidad con prestaciones de seguridad mejoradas
  - Sistema de plegado seguro
  - Trasera metálica antioxidante
- FR**
  - Stop-trottoir de haute qualité avec des caractéristiques de sécurité spéciales
  - Mécanisme de pliage de loquet de sécurité
  - Panneau arrière en métal non corrosif



Art. nr.	DIN/Size	Dimensions (cm)			
		W	H	D	KG
ZPZA1	A1	65,2	110	76	12,3
<b>Outdoor</b>					
ZPZA1WR	A1	65,2	110	76	14,2

Optional: Topcard for size A1 (see p. 101)

See accessory page for options (p. 100)

Graphic available

89

DESIGN COMPASSO® A-BOARD LOGO

- IT**
  - Cavalletto Premium con un'eccezionale durevolezza
  - Opzione logo sulla parte superiore unica
  - Perfetto per le entrate dei negozi e dei centri commerciali
- ES**
  - Caballete Premium extremadamente duradero
  - Espacio extra para su logo
  - Perfecto para las entradas de las tiendas y centros comerciales
- FR**
  - Stop-trottoir haut de gamme avec une durabilité extrême
  - Option unique de logo sur la partie supérieure
  - Parfait pour les entrées de magasin et les centres commerciaux



Art. nr.	DIN/Size	Dimensions (cm)			
		W	H	D	KG
ZPC1A1	A1	66	79,3	79,3	18,5
<b>Integrated Topcard</b>					
	A1	64,7	20,4		



- Integrated Topcard included
- Optional: Personalise with your own branding or logo with Topcard for Design Compasso® A-Board A1 (see p. 101)



25 MM PROFILE A-BOARD DESIGN STANDARD

- IT**
  - Bestseller
  - Utilizzo interno o in aree coperte
  - Bifacciale
- ES**
  - Best seller
  - Uso interior o en zonas cubiertas
  - De doble cara
- FR**
  - Best-seller
  - Utilisation en intérieur ou zones couvertes
  - Double-face



BESTSELLER

Art. nr.	DIN/Size	Dimensions (cm)			
		W	H	D	KG
ZPA2G25	A2	45,1	98	67,4	5
ZPA1G25	A1	62,5	107,5	73,6	6,8
ZP50x70G25	50 x 70	98	67,4	53,1	5,9
ZP70x100G25	70 x 100	91,7	136,1	73,1	9
ZPA2R25	A2	100,6	67,4	45,1	4,7
ZPA1R25	A1	73,6	110,1	62,5	6,6
ZP50x70R25	50 x 70	53,1	100,6	67,4	5,7
ZP70x100R25	70 x 100	73,1	138,1	91,7	8,8



- Optional: Brochure Basket (see p. 100)



**A-BOARD FABRIC MOVE**

PATENTED

BESTSELLER

- IT**
  - Facile da spostare per la sua leggerezza e la borsa per il trasporto
  - Con facile attacco in velcro delle grafiche
  - Facile allestimento grazie a un assemblaggio che non necessita attrezzi
- ES**
  - Fácil movimiento gracias al peso ligero y una bolsa de transporte
  - Con una colocación de la gráfica fácil mediante velcro
  - Fácil montaje sin necesidad de usar herramientas
- FR**
  - Facile à déplacer grâce à sa légèreté et à son sac de transport
  - Avec fixation facile du visuel par Velcro
  - Installation facile grâce à un montage sans outil



Art. nr.	DIN/Size	Dimensions (cm)			
		W	H	D	KG
ZPMA1	A1	69	105	74	2,7

- Included with a luxurious soft carry bag
- Same system as the well-known Zipper-Wall tube systems



now available with imprint →



**CHALK A-BOARD SWING**

- IT**
  - Cavalletto con lavagna in acciaio nero da esterno industriale ed elegante
  - Condividi i messaggi con un pennarello a gesso bianco
  - Perfetto per il mercato dell'accoglienza
- ES**
  - Caballete de pizarra para escribir con tiza, de acero negro, estilizada y con apariencia industrial para el uso en exteriores
  - Comparta el contenido escribiendo con un rotulador de tiza
  - Perfecto para el mercado de la hostelería
- FR**
  - Tableau noir d'extérieur en acier, élégant et industriel
  - Partager des messages avec un marqueur craie blanc
  - Parfait pour le marché de l'hôtellerie et de la restauration

Art. nr.	DIN/Size	Dimensions (cm)			
		W	H	D	KG
ZPSW50x70	50 x 70	57,2	95,9	69,6	4,1

- Included white chalkmarker





## A-BOARD ELEGANT STEEL

- IT**
- Un design elegante e robusto in acciaio
  - Pannello di protezione anteriore con bordi per la facile sostituzione dei poster
  - Elegante finitura nera
- ES**
- Diseño de acero elegante y robusto
  - Plástico protector de carteles con cinta magnética para facilitar el intercambio de carteles
  - Revestido con un elegante acabado negro
- FR**
- Design élégant et robuste en acier
  - Film de protection des affiches avec bande magnétique pour changement facile des affiches
  - Revêtu d'une finition noire élégante



Art. nr.	DIN/Size	Dimensions (cm)			
		W	H	D	KG
ZPESA1BL	A1	67	104,5	71,5	12,3
ZPES50x70BL	50x70	57,5	96,5	64	9,7
ZPES70x100BL	70x100	77,5	116	85,5	15,3

## A-BOARD ELEGANT STEEL WITH LOGO PANEL

- IT**
- Diseño de acero elegante y robusto
  - Plástico protector de carteles con cinta magnética para facilitar el intercambio de carteles
  - Panel fijo para logotipo en la parte superior
- ES**
- Design élégant et robuste en acier
  - Film de protection des affiches avec bande magnétique pour changement facile des affiches
  - Panneau logo fixe en partie supérieure
- FR**
- Design in acciaio elegante e robusto
  - Lamina protettiva per poster con nastro magnetico per un facile cambio dei poster
  - Pannello con logo fisso sulla parte superiore



Art. nr.	DIN/Size	Dimensions (cm)			
		W	H	D	KG
ZPESA1BLTOP	A1	70	128	70	14
ZPES50x70BLTOP	50x70	61	119	70	12

• For indoor and covered outdoor use

NEW



NEW



## A-BOARD SLIDE IN

- IT**
- Scegli tra pannelli BOND o FOREX®
  - Aggiornamento rapido dei contenuti con inserimento dall'alto
  - Cavalletto in acciaio resistente agli agenti atmosferici

- ES**
- Elige entre paneles de BOND o FOREX®
  - Cambio rápido del contenido deslizando desde la parte superior
  - Caballete de acero resistente a la intemperie

- FR**
- Choix entre panneaux BOND ou FOREX®
  - Mise à jour rapide en glissant le panneau par le haut
  - Panneau trottoir en acier résistant aux intempéries



Art. nr.	DIN/Size	Dimensions (cm)			
		W	H	D	KG
ZPSFA1	A1	60,5	97,8	58,8	5,3

## CITY SIGN ELEGANT STEEL

- IT**
- Base circular para mayor seguridad en la acera
  - Expositor exterior de doble cara
  - Parte superior redondeada, perfecta para la personalización de marca

- ES**
- Design élégant et robuste en acier
  - Film de protection des affiches avec bande magnétique pour changement facile des affiches
  - Panneau logo fixe en partie supérieure

- FR**
- Base circolare per una maggiore stabilità sul marciapiede
  - Espositore da esterno bifacciale
  - Parte superiore arrotondata, ideale per il branding

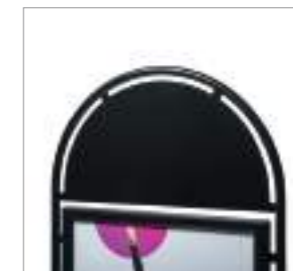

Art. nr.	DIN/Size	Dimensions (cm)			
		W	H	D	KG
CSESA1BLTOP	A1	74	148	74	21,5
CSES50x70BLTOP	50x70	64	130	64	18

For indoor and covered outdoor use

### A-BOARD GRAB & GRIP

NEW

PATENTED

- IT**
  - Assemblaggio rapido e senza sforzo con le impugnature
  - Da 2 pannelli in un cavalletto in pochi secondi
  - Cavalletto robusto e resistente alle intemperie per uso interno ed esterno coperto
- ES**
  - Montaje rápido y sin esfuerzo con asas
  - De 2 paneles a 1 A-Board promocional en un segundo
  - Tablero duradero y resistente a la intemperie para uso en interiores y exteriores cubiertos
- FR**
  - Installation rapide et sans effort à l'aide du système de fixation
  - De 2 panneaux à 1 chevalet promotionnel en quelques secondes
  - Panneau fiable et résistant aux intempéries pour une utilisation en intérieur et en extérieur couvert

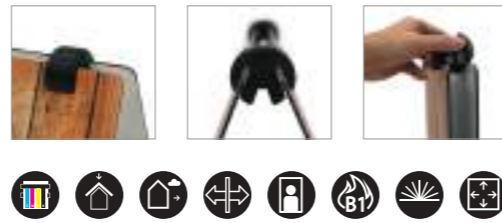

Art. nr.	DIN/Size	Dimensions (cm)			
		W	H	D	KG
ZPGA2	A2	59,4	84,1	0,3	4
ZPGA1	A1	42	59,4	0,3	2
ZPG50x70	50x70	50	70	0,3	2,8

Choose white or custom-printed BOND boards

### A-BOARD GRAB & GRIP BLACK

NEW

PATENTED

- IT**
  - Disponibili pannelli bianchi o personalizzati in BOND
  - Montaggio rapido e semplice grazie ai morsetti
  - Disponibile esclusivamente presso Showdown Displays Europe
- ES**
  - Paneles BOND negros escribibles con opción de impresión superior
  - Apto para rotuladores de tiza líquida
  - Exclusivo en Showdown Displays Europe
- FR**
  - Panneaux noirs BOND inscriptibles avec option d'impression supérieure
  - Convient aux marqueurs craie liquide
  - Disponible exclusivement chez Showdown Displays Europe

now available with imprint

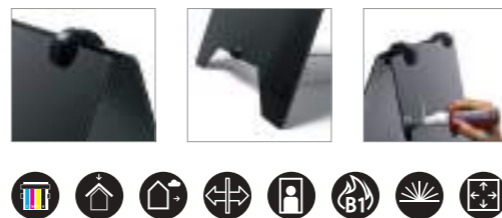

Art. nr.	DIN/Size	Dimensions (cm)			
		W	H	D	KG
ZPGA1CHB	A2	59,4	84,1	0,3	4
ZPGA2CHB	A1	42	59,4	0,3	2
ZPG50x70CHB	50x70	50	70	0,3	2,8



### A-BOARD STICK-ON

- IT**
  - Struttura in alluminio stabile e robusta
  - Materiale robusto e resistente alle intemperie (BOND)
  - L'Omni Velcro incluso per fissare pannelli di ogni materiale
- ES**
  - Estructura de aluminio resistente y robusta
  - Tablero duradero y resistente a la intemperie (BOND)
  - Incluye Omni Velcro para sujetar cualquier material en el tablero
- FR**
  - Structure en aluminium stable et résistant
  - Panneau robuste et résistant aux intempéries (BOND)
  - Velcro Omni inclus pour la fixation de panneaux de divers matériaux



Art. nr.	DIN/Size	Dimensions (cm)			
		W	H	D	KG
ZPSOA2-HW	-	2,5	98	68,5	1,4
+ FBZPSOA2SET-BW3	A2	42	59,4	0,5	2,1
ZPSOA1-HW	-	2,5	108,5	82	1,4
+ FBZPSOA1SET-BW3	A1	59,4	84,1	0,5	4,1
ZPSO50x70-HW	-	2,5	98	68,5	1,4
+ FBZPSO50x70SET-BW3	50x70	50	70	0,5	2,9

For indoor and covered outdoor use



### SPLASHPROOF POSTER BAG

Accessory for Snap Frames, A-Boards and Windtalkers®



- IT** • Durata della locandina maggiore - busta in PVC resistente ai raggi UV
- ES** • Vida útil prolongada del póster: bolsa de PVC resistente a los rayos UV
- FR** • Prolongation de la durée de vie des affiches - enveloppe en PVC résistant aux UV

Art. nr. WRBAGA4  
WRBAGA3  
WRBAGA2  
WRBAGA1  
WRBAG50x70  
WRBAG70x100

### TOPCARD + WIREFRAME SET

Accessory for 32 mm Profile A-Board, DIN A1



- IT** • Espositore in PVC per applicazione di stampe o etichette in vinile
- ES** • Recuadro superior de PVC espumado adecuado para aplicaciones en carteles de vinilo o impresión
- FR** • Topcard en PVC adaptée à l'impression ou à l'application de signalisation en vinyle

Art. nr. TSZPA1

### BROCHURE BASKET

Accessory for 25 mm Profile A-Board Design Standard, 32 mm Profile A-Board and Design Compasso® A-Board



- IT** • Finitura zincata per una lunga durata
- ES** • Acabado galvanizado para mayor durabilidad
- FR** • Finition galvanisée pour plus de durabilité

Art. nr. LHZPA4  
LHZPA5

### TOPCARD FOR 32 MM PROFILE A-BOARD A1

Accessory for 32 mm Profile A-Board A1



- IT** • Materiale pannello FOREX® da 3 mm
- Marchio fronte-retro o messaggio pubblicitario altamente visibile
- ES** • Material del tablero FOREX® de 3 mm
- Mensaje publicitario o branding a doble cara aumenta la visibilidad
- FR** • Matériau du panneau : FOREX® de 3 mm
- Marquage ou message publicitaire double face très visible

Art. nr. FBTSPA1-FP3

### TOPCARD FOR DESIGN COMPASSO® A-BOARD LOGO A1

Accessory for Design Compasso® A-Board Logo A1



- IT** • Materiale pannello FOREX® da 3 mm
- Marchio fronte-retro o messaggio pubblicitario altamente visibile
- ES** • Material del tablero FOREX® de 3 mm
- Mensaje publicitario o branding a doble cara aumenta la visibilidad
- FR** • Matériau du panneau : FOREX® de 3 mm
- Marquage ou message publicitaire double face très visible

Art. nr. FBTOPZPC1A1-FP3

### TOPCARD FOR DESIGN A-BOARD PRIME A1

Accessory for Design A-Board Prime A1



- IT** • Materiale pannello FOREX® da 3 mm
- Marchio fronte-retro o messaggio pubblicitario altamente visibile
- ES** • Material del tablero FOREX® de 3 mm
- Mensaje publicitario o branding a doble cara aumenta la visibilidad
- FR** • Matériau du panneau : FOREX® de 3 mm
- Marquage ou message publicitaire double face très visible

Art. nr. FBTOPZPZA1-FP3

### POSTER FOIL, FOIL SET

Accessory for A-Boards and Snap Frames



- IT** • Copertura locandina stabile ai raggi UV antiriflesso
- ES** • Folio protector antirreflejos y anti-UV
- FR** • Protection antireflet résistante aux UV pour les posters

Art. nr. Foil (5 pcs) Foilset (2 pcs)  
FOILA4 SETFZPA4  
FOILA3 SETFZPA3  
FOILA2 SETFZPA2  
FOILA1 SETFZPA1  
FOILA0 SETFZPA0  
FOIL50x70 SETFZP50x70  
FOIL70x100 SETFZP70x100  
SETFZP100x140

### SET OF 2 BLACK WRITING FOILS AND 3 CHALK PENS

Accessory for A-Boards, Windtalker® and Snap Frames



- IT** • Pennarelli a gesso rosa, bianco e verde
- ES** • Marcadores de tiza líquida en colores rosa, blanco y verde
- FR** • Feutres craie en rose, blanc et vert

Art. nr. 2 Black Foils  
SETWFA3  
SETWFA2  
SETWFA1  
SETWFA0  
SETWF50x70  
SETWF70x100

### GRAB & GRIP ACCESSORY SET

Accessory for A-Board Grab & Grip



- IT** • Set composto da due morsetti e un supporto inferiore
- ES** • Set de dos agarres y un soporte inferior
- FR** • Ensemble comprenant deux pinces et un support inférieur

Art. nr. ZPG-HW

BESTSELLER



## WINDTALKER® CITY WITH PLASTIC BASE

- IT**
  - Grosse molle in metallo per grande resistenza al vento
  - Sistema di cornici a clip su 2 lati
  - Base in plastica da riempire con acqua o sabbia
- ES**
  - Muelles de acero gruesos para resistir al viento fuerte
  - Sistema de marco abatible en ambas caras
  - Base de plástico rellenable con agua o arena
- FR**
  - Ressorts métalliques épais en cas de vent fort
  - Système de cadre à pince sur 2 côtés
  - Base en plastique pour remplissage avec de l'eau ou du sable

Art. nr.	DIN/Size	☒	Dimensions (cm)			KG
			W	H	D	
WTRA1	A1	○	67	112,3	59	13,8
WTRA0	A0	○	88,7	149,7	83,5	23,6
WTR50x70	50 x 70	○	63,5	98,2	59	10,7
WTR70x100	70 x 100	○	83,5	130,8	83,5	19,4
WTRA1BLK	A1	●	67	112,3	59	13,8
WTRA0BLK	A0	●	88,7	149,7	88,7	23,6
WTR70x100BLK	70 x 100	●	83,5	130,8	83,5	19,4
<b>Weatherproof (Splashproof)</b>						
WTRA1WR	A1	○	67	112,3	59	13,8
WTR70x100WR	70 x 100	○	83,5	130,8	83,5	19,4
WTRA1WRBLK	A1	●	67	112,3	59	13,8
WTR70x100WRBLK	70 x 100	●	83,5	130,8	83,5	19,4

- ☒ Windtalker® PVC Cover, Splashproof Poster Bag and Topcard for A1 Windtalker® City (see p. 103)
- ☒ Leaflet Holder available on request



### SPLASHPROOF POSTER BAG

Accessory for Snap Frames, A-Boards and Windtalkers®



- IT**
  - Durata della locandina maggiore - busta in PVC resistente ai raggi UV
- ES**
  - Vida útil prolongada del póster: bolsa de PVC resistente a los rayos UV
- FR**
  - Prolongation de la durée de vie des affiches - enveloppe en PVC résistant aux UV

Art. nr. WRBAGA4  
WRBAGA3  
WRBAGA2  
WRBAGA1  
WRBAG50x70  
WRBAG70x100

### TOPCARD FOR WINDTALKER® CITY A1

Accessory for Windtalker® City with Plastic Base A1



- IT**
  - Materiale pannello FOREX® da 3 mm
  - Marchio fronte-retro o messaggio pubblicitario altamente visibile
- ES**
  - Material del tablero FOREX® de 3 mm
  - Mensaje publicitario o branding a doble cara aumenta la visibilidad
- FR**
  - Matériau du panneau : FOREX® de 3 mm
  - Marquage ou message publicitaire double face très visible

Art. nr. FBTSWTRA1-FP3



### WINDTALKER® EXCEL WITH PLASTIC BASE

- IT**
- Safety design with moulded end caps
  - Easy change of poster
  - Reinforced springs with a kick proof twin wall centre panel for durability
- ES**
- Sicherheits Design mit geformten Endkappen
  - Einfacher Wechsel des Plakats
  - Verstärkte Federn und eine schlagfeste Trennwand für eine lange Lebensdauer
- FR**
- Design met veilige hoeken
  - Eenvoudig verwisselen van poster
  - Versterkte veren met een kickproof dubbelwandig middenpaneel voor duurzaamheid



Art. nr.	DIN/Size	Dimensions (cm)			
		W	H	D	KG
WTEA1	A1	62,5	121,5	50	17,5
WTEA0	A0	87,4	159,6	65	26,8
WTE70x100	70 x 100	81,2	140,7	65	23,9

### WINDTALKER® EXCEL WITH METAL BASE

**NEW: SIZE**

- IT**
- Projecting steel legs for good stability
  - Safety design with no sharp edges
  - Snap Frame closing to the vertical sides giving added poster protection
- ES**
- Stahlbeine für eine gute Stabilität
  - Sicherheits Design ohne scharfe Kanten
  - Klapprahmen an den vertikalen Seiten einfach zu öffnen
- FR**
- Stalen poten voor optimale stabiliteit
  - Veiligheid design zonder scherpe randen
  - Kliklijst sluit aan de verticale zijden voor extra posterbescherming



Art. nr.	DIN/Size	Dimensions (cm)			
		W	H	D	KG
WTEEA1	A1	62,4	1120	96	16,5
WTEEA0	A0	87,1	146,8	130,5	20,1
WTEE70x100	70x100	73	128	111,5	14,1

**NEW**



## 6. LEAFLET AND CATALOGUE HOLDERS

Porta cataloghi e porta informazioni  
Portafolletos y Catálogos  
Porte-dépliants et Catalogues

Leaflet and Catalogue Holders will draw attention to your promotional literature. From flyers to brochures and leaflets, you can display any literature you want. Choose the one that suits you best: Catalogue racks, foldable brochure holders or rotating brochure stands. Ideal to use in a showroom, in the office, any point of sale or exhibitions and events.

### INDEX

6.1 Leaflet and Catalogue Holders **108**  
Porta cataloghi e porta informazioni  
Portafolletos y Catálogos  
Porte-dépliants et Catalogues

- **MADE OF HIGH QUALITY ACRYLIC GLASS AND ALUMINIUM**
- **PERFECT FIT FOR DIFFERENT DIN SIZES**
- **GREAT SOLUTION FOR RETAIL AND OFFICES**

### ✓ GOOD BROCHURE HOLDER DESIGN STANDARD

- Lightweight and stable
- Clear styrene holder
- Option for customised logo panel

### 👍 BETTER BROCHURE RACK TOTEM

- Freestanding totem with brochure shelves
- Easy mounting
- Silver anodised aluminium profiles

### 🏆 BEST SLIM CATALOGUE STAND

- Magnetic poster display for customised branding
- Attractive look with aesthetic design
- High capacity of A4 literature

**BROCHURE HOLDER DESIGN STANDARD**

- IT**
- Leggero e stabile
  - Contenitore in stirene trasparente
  - Possibilità di inserto con logo personalizzato
- ES**
- Ligero y estable
  - Soporte de estireno transparente
  - Opción de panel con logotipo personalizado
- FR**
- Léger et stable
  - Support en styrène transparent
  - Option pour panneau de logo personnalisé

**BESTSELLER**



Art. nr.	DIN/Size	Dimensions (cm)			
		W	H	D	KG
MB3C160	3 x A5	33	106	33	4,8
MB3C230	3 x A4	33	116,5	33	5,2
MB4C110	4 x DL	33	106	33	2,6
MB4C160	4 x A5	33	106	33	4,8
MB4C230	4 x A4	33	111,5	33	5,3
MB4C330	5 x A4	33	111,5	33	4,9

Brochure Holder Design Standard (p. 108/ch. 6), Scritto® Corkboard (p. 175 /ch 11)

**BESTSELLER**



**BROCHURE RACK TOTEM**

- IT**
- Totem da pavimento con ripiani per brochure
  - Facile da montare
  - Profili argentati in alluminio anodizzato
- ES**
- Tótem de pie con estantes para catálogos
  - Montaje fácil
  - Bordes de aluminio anodizado en plata
- FR**
- Totem sur pied avec étagères pour brochures
  - Montage facile
  - Profils en aluminium anodisé argent



Art. nr.	DIN/Size	Dimensions (cm)			
		W	H	D	KG
<b>Rack with pockets set</b>					
BRT4S	● A4	37	167,4	41,7	13,8
BRTBL4S	● A4	41,7	167,4	37	13,7



### SLIM CATALOGUE STAND

- IT**
  - Espositore pubblicitario magnetico per marchi personalizzati
  - Aspetto accattivante con design estetico
  - Può contenere grandi quantità di materiale informativo in formato A4
- ES**
  - Expositor magnético para personalizar su branding
  - Look atractivo con diseño estético
  - Alta capacidad de folletos DIN A4
- FR**
  - Poster magnétique pour un branding personnalisé
  - Look attrayant avec un design esthétique
  - Capacité élevée de documents A4



Art. nr.	DIN/Size	Dimensions (cm)			
		W	H	D	KG
CSA4C9005	A4	27	115,2	30,1	10,2

Other colours available on request

### LEAFLET STAND WITH MAGNETIC POCKET

- IT**
  - Tasca magnetica per comodità dell'utilizzatore
  - Design elegante per un'estetica eccezionale
  - Struttura stabile e affidabile
- ES**
  - Marco magnético para la comodidad del usuario
  - Diseño elegante para mejor estética
  - Estable y de estructura sólida
- FR**
  - Pochette magnétique pour plus de commodité
  - Conception intelligente pour une esthétique exceptionnelle
  - Structure stable et fiable



Art. nr.	DIN/Size	Dimensions (cm)			
		W	H	D	KG
MBMA4PC9005	A4	21,8	115,2	21,8	7,3

Other colours available on request

### ZIG ZAG BROCHURE STAND FOLDABLE

- IT**
  - Struttura in alluminio dotata di 4 piedini in gomma
  - Facile e veloce da assemblare
  - Lussuosa e solida custodia da trasporto con serratura e protezione interna in schiuma
- ES**
  - Perfil de aluminio y 4 pies de goma
  - Fácil de montar
  - Incluye funda sólida con una capa de espuma interior para mayor pro
- FR**
  - Cadre en aluminium, équipé de 4 pieds en caoutchouc
  - Facile à installer
  - Comprend un boîtier solide avec mousse et protection à l'intérieur



Art. nr.	DIN/Size	Dimensions (cm)			
		W	H	D	KG
BHZZA	A4	28	143	35	8,4

### BROCHURE HOLDER DELUXE

- IT**
  - Portadepliant estremamente stabile che occupa uno spazio minimo
  - Contenitori in acrilico trasparente
  - Borsa imbottita rinforzata con cerniera
- ES**
  - Muy estable y con una ocupación de espacio mínima
  - Acrílicos transparentes
  - Bolsa de transporte acolchada con cremallera
- FR**
  - Porte-brochures extrêmement stable qui occupe un espace minimal
  - Porte-brochures en acrylique transparent
  - Sac rembourré renforcé avec fermeture à glissière



Art. nr.	DIN/Size	Dimensions (cm)			
		W	H	D	KG
BHL	A4	24	156	29	6,8

# HOSPITALITY

Hospitality  
Hostelería  
Hospitalité



Make sure your menu or information pops out thanks to the various hospitality displays. Suitable for restaurants, hotels, cafes or other hospitality establishments. Stay authentic and optimise your promotion with our various designs, materials and sizes.

## BEACH CHAIR RELAX COMFORT

See 19. Tents, Umbrellas and Seats  
page 298



NEW



## T STAND LED

See 8. Menu Displays  
page 141

## WOODEN A-BOARD FLIP ECONOMY

See 7. Wooden Signs  
page 117



## CHALK A-BOARD SWING

See 5. Pavement Signs  
page 93

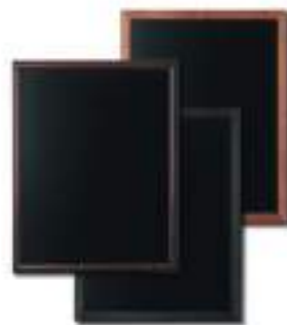

## NATURA CHALK BOARDS

See 7. Wooden Signs  
page 122



## WOODEN SHOWCASE

See 8. Menu Displays  
page 134



## OUTDOOR MENU FRAME STAND BLACK

See 8. Menu Displays  
page 130



## BEACH FLAG ALU PADDLE

See 16. Flags  
page 242

## OUTDOOR MENU CASE LOGO / LED

See 8. Menu Displays  
page 135



## ALUMINIUM A-BOARDS

See 5. Pavement Signs  
page 88



## A-BOARD ELEGANT STEEL WITH LOGO PANEL

See 5. Pavement Signs  
page 95



## LOCKABLE MENU STAND LOGO / LED

See 8. Menu Displays  
page 133



## A-BOARD ELEGANT STEEL

See 5. Pavement Signs  
page 94



## HORECA UMBRELLA ANTIQUE

See 19. Tents, Umbrellas and Seats  
page 294



## HORECA UMBRELLA SLIDE

See 19. Tents, Umbrellas and Seats  
page 295

## interesting categories for you

1. POSTER FRAMES AND DISPLAYS	14
2. TEXTILE FRAMES	38
4. DIGITAL DISPLAYS	62
5. PAVEMENT SIGNS	86
7. WOODEN SIGNS	114
8. MENU DISPLAYS	128
9. OUTDOOR EQUIPMENT	146
11. FLIPCHARTS AND WRITABLE BOARDS	170
12. WAYFINDING SYSTEMS	178
15. BANNERS	206
16. FLAGS	234

## 7. WOODEN SIGNS

Espositori in legno  
Carteles en Madera  
Panneaux en Bois

Wooden Signs offer an authentic, antique and vintage look. A-Boards, chalkboards and table top displays are made from durable hardwood or MDF. Easy to clean and allow you to quickly change your message. Ideal for restaurants, bars, cafes and other hospitality establishments.

- ✦ HIGH QUALITY STAINED (HARD)WOOD OR MDF PROFILE
- ✦ SUITABLE FOR CHALKMARKERS AND EASY TO CLEAN
- ✦ DIFFERENT WOODEN DESIGNS TO MATCH DIFFERENT INTERIORS WITH INDIVIDUAL BRANDING OPTIONS

### INDEX

- |  |            |
|--|------------|
| 7.1 Wooden Chalk A-Boards<br><i>Cavalletti in legno con lavagna</i><br><i>Caballetes de Madera</i><br><i>Stop-trottoirs en Bois pour Craie</i> | <b>116</b> |
| 7.2 Wooden Chalk Boards<br><i>Cavalletti in legno con lavagna</i><br><i>Pizarras de Madera</i><br><i>Tableaux en Bois pour Craie</i>           | <b>121</b> |
| 7.3 Wooden Table Tops<br><i>Porta informazioni da tavolo in legno</i><br><i>Pizarra de Sobremesa</i><br><i>Dessus de Table en Bois</i>         | <b>125</b> |



#### ✓ GOOD NATURA CHALK A-BOARD CLASSIC

- Lightweight wood
- Economy version A-Board
- Stained wood with matt varnish protection



#### 👍 BETTER NATURA CHALK FAST-SWITCH A-BOARD

- Hardwood A-Board for stylish atmosphere
- Rounded top look
- Effortless chalk panel switch



#### 🏆 BEST NATURA CHALK A-BOARD ANTIQUE

- Rustic vintage look
- 40 mm hardwood frame with chalk board
- Matt varnish protection



**WOODEN A-BOARD ECONOMY**

- IT**
  - Facile da richiudere e trasportare
  - Leggera ma robusta
  - Adatta per esterni al coperto
- ES**
  - Fácil de plegar y transportar
  - Ligera pero robusta
  - Adecuada para exteriores cubiertos
- FR**
  - Facile à plier et à transporter
  - Léger, mais robuste
  - Convient aux espaces extérieurs couverts



Art. nr.	DIN/Size	📏	Dimensions (cm)			
			W	H	D	KG
ZPCHELB51x65	51 x 65	●	55	82	51,5	4,8

📌 As this is a natural product, the colours can slightly differ



**WOODEN A-BOARD FLIP**

- IT**
  - Lavagna a cavalletto unica & bifacciale
  - Lavagna elegante di aspetto rustico in legno di faggio
  - Adatta per esterni al coperto
- ES**
  - Con un giro de tablero es posible escribir mensajes en ambos lados
  - Pizarra rústica de madera de haya
  - Apto para uso en exteriores bajo techo
- FR**
  - Basculement unique du panneau pour les messages sur les deux faces
  - Charmant tableau rustique en bois de hêtre
  - Convient aux espaces extérieurs couverts

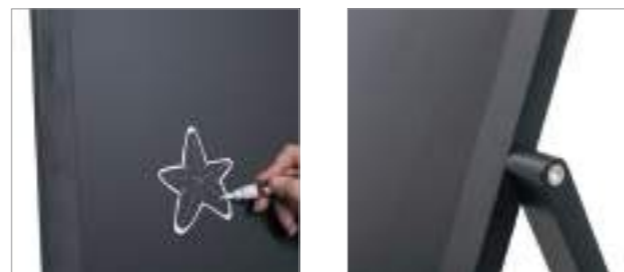

Art. nr.	DIN/Size	📏	Dimensions (cm)			
			W	H	D	KG
ZPCHFLB68x140	62 x 114	●	68	134	64	5,7
ZPCHFLB55x105	49 x 89	●	55	100,5	53	3,9
ZPCHFLB68x140	62 x 114	●	68	134	64	5,7
ZPCHFLB55x105	49 x 89	●	55	100,5	53	3,9



### NATURA CHALK A-BOARD

- IT**
  - Adatti per aree interne ed esterne coperte
  - Profilo piatto in legno di alta qualità
  - Cerniere in acciaio zincato
- ES**
  - Uso tanto interior como en exterior cubierto
  - Perfil de madera plana de alta calidad
  - Bisagras de acero galvanizado
- FR**
  - Convient aux zones intérieures et extérieures couvertes
  - Profil en bois dur plat de haute qualité
  - Charnières en acier galvanisé

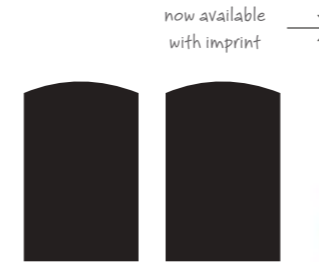

now available with imprint →



Art. nr.	DIN/Size	☒	Dimensions (cm)			
			W	H	D	KG
ZPCHBLB55x85	55 x 85	●	55	81,5	56,7	7,7
ZPCHBLB68x120	68 x 120	●	68	114,8	78,4	13,2
ZPCHBBR55x85	55 x 85	●	55	81,5	58,6	7,7
ZPCHBBR68x120	68 x 120	●	68	114,8	80,3	13,2
ZPCHBBL55x85	55 x 85	●	55	81,5	56,7	7,7
ZPCHBBL68x120	68 x 120	●	68	114,8	78,4	13,2



As this is a natural product, the colours can slightly differ

### NATURA CHALK A-BOARD CLASSIC

- IT**
  - Legno leggero
  - Lavagna a cavalletto economica
  - Legno pitturato e protetto con vernice opaca
- ES**
  - Madera ligera
  - Versión económica de pizarras de caballete
  - Madera tratada con barniz protector mate
- FR**
  - Bois léger
  - Stop-trottoir économique
  - Bois teinté avec protection vernie mate



Art. nr.	DIN/Size	☒	Dimensions (cm)			
			W	H	D	KG
ZPCHBELB55x85	55 x 85	●	55	82,5	50	4
ZPCHBEER55x85	55 x 85	●	55	82,5	50	4
ZPCHBEEL55x85	55 x 85	●	55	82,5	50	4

As this is a natural product, the colours can slightly differ

### NATURA CHALK FAST-SWITCH A-BOARD

- IT**
  - Cavalletto in legno per un'atmosfera elegante
  - Parte superiore arrotondata
  - Cambio lavagna senza sforzo
- ES**
  - Pizarra de Caballete Fast Switch de madera noble para crear un ambiente con estilo
  - Aspecto redondeado de la parte superior
  - Cambio de panel de escritura sin esfuerzo
- FR**
  - Stop-trottoir en bois dur pour une atmosphère élégante
  - Partie supérieure arrondie
  - Changement facile de tableau noir



Art. nr.	DIN/Size	☒	Dimensions (cm)			
			W	H	D	KG
ZPCHBFSLB55x85	55 x 85	●	55	86,2	58,6	6,5
ZPCHBFSLB68x120	68 x 120	●	68	119,7	80,2	10,4

Optional: Brand with your logo





now available with imprint →



## NATURA CHALK A-BBOARD ANTIQUE

- IT**
- Aspetto vintage e rustico
  - Cornice in legno da 40 mm con lavagna
  - Protezione con vernice opaca
- ES**
- Estilo vintage y rústico
  - Perfil de madera noble de 40 mm con pizarra de tiza
  - Barniz protector mate
- FR**
- Look rustique vintage
  - Cadre en bois dur de 40 mm avec tableau noir
  - Protection vernie mate

Art. nr.	DIN/Size	Dimensions (cm)				KG
		W	H	D		
ZPCHBLX59x116	59 x 116	59	107	103,2		13

Optional: Brand with your logo



## NATURA CHALK BOARD CLASSIC

- IT**
- Aspetto vintage e antico
  - Facile pulizia a secco
  - Legno pitturato e protetto con vernice opaca
- ES**
- Estilo vintage y rústico
  - Borrado en seco
  - Madera tratada con barniz protector mate
- FR**
- Aspect ancien
  - Nettoyage facile à sec
  - Bois teinté avec protection vernie mate



Art. nr.	DIN/Size		Dimensions (cm)				KG
			W	H	D		
CHBELB50x60	50 x 60	●	50	60	2	7,3	
CHBELB60x80	60 x 80	●	60	80	2	8	
CHBELB70x90	70 x 90	●	70	90	2	9	
CHBEBR50x60	50 x 60	●	50	60	2	7,3	
CHBEBR60x80	60 x 80	●	60	80	2	8	
CHBEBR70x90	70 x 90	●	70	90	2	9	
CHBEBL50x60	50 x 60	●	50	60	2	7,3	
CHBEBL60x80	60 x 80	●	60	80	2	8	
CHBEBL70x90	70 x 90	●	70	90	2	9	



Natura Chalk Board Classic (p. 121/ch. 7) and Natura Table Top Chalk Board (p. 126/ch. 7)



BESTSELLER



## NATURA CHALK BOARD

- IT**
- Profili piatti in legno di alta qualità
  - Pannelli truciolari nobilitati in MFC
  - Disponibile in un'ampia gamma di formati

- ES**
- Perfil plano de madera noble de alta calidad
  - Paneles de aglomerado de melamina MFC
  - Disponible en una amplia gama de tamaños

- FR**
- Profils plats en bois dur de haute qualité
  - Panneaux agglomérés à face mélaminée MFC
  - Disponibles dans une large gamme de dimensions

Art. nr.	DIN/Size		Dimensions (cm)			
			W	H	D	KG
CHBLB30x40	30 x 40	●	30	40	2	1,4
CHBLB40x50	40 x 50	●	40	50	2	2,1
CHBLB50x60	50 x 60	●	50	60	2	2,9
CHBLB60x80	60 x 80	●	60	80	2	5,3
CHBLB70x90	70 x 90	●	70	90	2	6,8
CHBLB40x120	40 x 120	●	40	120	2	5,4
CHBLB56x100	56 x 100	●	56	100	2	6,1
CHBLB56x120	56 x 120	●	56	120	2	7,2
CHBLB56x150	56 x 150	●	56	150	2	7,3
CHBLB56x170	56 x 170	●	56	170	2	8,2
CHBBL30x40	30 x 40	●	30	40	3	1,3
CHBBL40x50	40 x 50	●	40	50	3	2
CHBBL50x60	50 x 60	●	50	60	3	2,8
CHBBL60x80	60 x 80	●	60	80	3	5,3
CHBBL70x90	70 x 90	●	70	90	3	6,8
CHBBL40x120	40 x 120	●	40	120	3	4,4
CHBBL56x100	56 x 100	●	56	100	3	6,1
CHBBL56x120	56 x 120	●	56	120	3	5,9
CHBBL56x150	56 x 150	●	56	150	3	8,9
CHBBL56x170	56 x 170	●	56	170	3	8,2

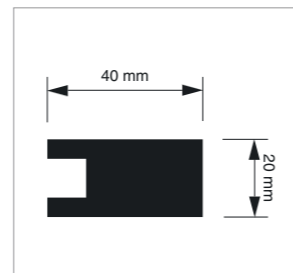

As this is a natural product, the colours can slightly differ

## NATURA EASEL

- IT**
- Supporto per dare maggiore esposizione alle lavagne
  - Disponibile in due colori
  - Legno tinto con protezione con vernice opaca

- ES**
- Soporte para darle mejor visibilidad a la pizarra
  - Disponible en 2 colores
  - Madera noble tratada con barniz protector mate

- FR**
- Support donnant une visibilité supplémentaire aux tableaux noirs
  - Disponible en 2 couleurs
  - Bois dur coloré avec protection vernie mate



now available with print

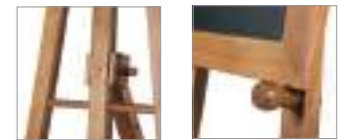

Art. nr.		Dimensions (cm)			
		W	H	D	KG
CHBLBEASEL	●	85	161	76	3,6
CHBBLEASEL	●	85	161	76	3,6



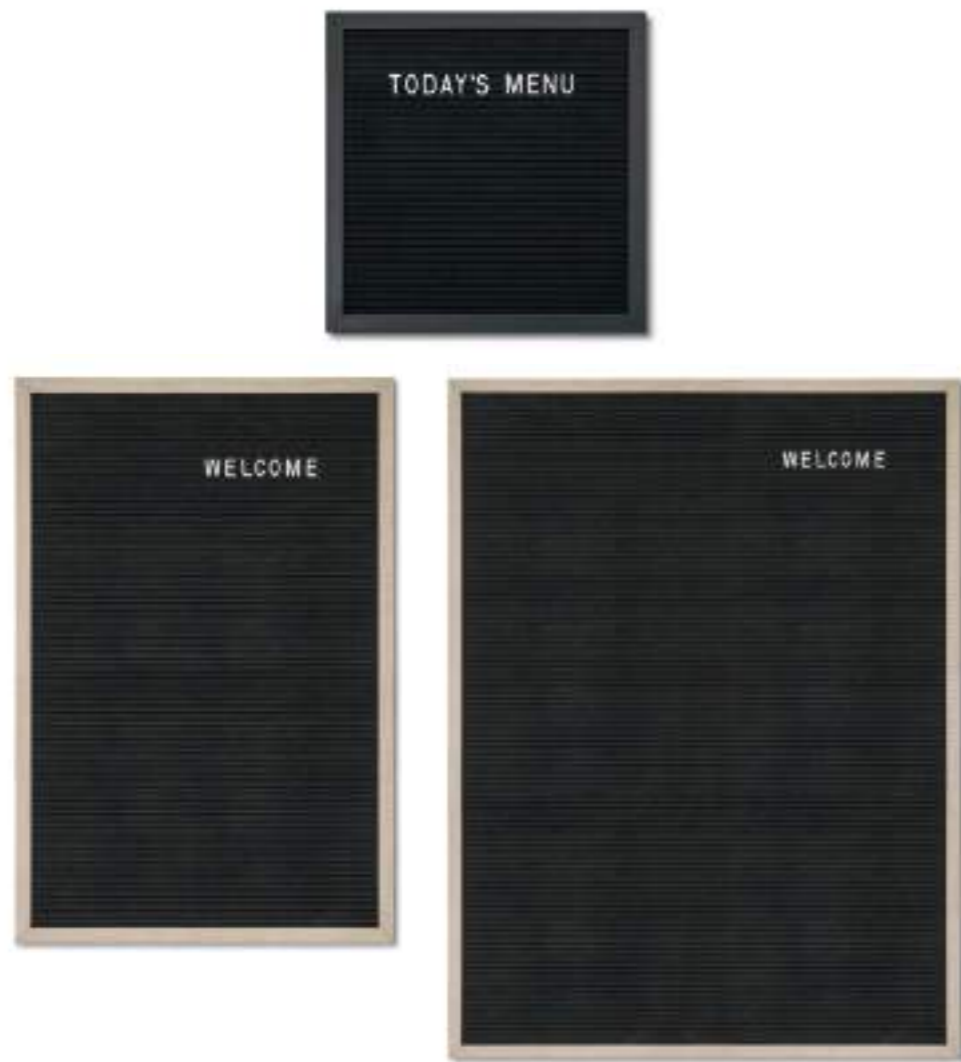

## BLACK LETTER BOARD

- IT**
- Cornice design vintage ed elegante
  - 330 lettere e 120 numeri compresi
  - Ideale per l'ospitalità e l'ufficio
- ES**
- Diseño de marco vintage y estilizado
  - 500 piezas de letras incluidas
  - Perfecto para la hostelería y las oficinas
- FR**
- Cadre au design vintage et élégant
  - 500 lettres sont incluses
  - Parfait pour le secteur de l'hospitalité et les bureaux



Art. nr.	DIN/Size	Dimensions (cm)				KG
		W	H	D		
LEB30x30	● 30 x 30	30	30	1,9	0,6	
LEB40x60	● 40 x 60	40	60	1,9	1,5	
LEB60x80	● 60 x 80	60	80	1,9	2,6	
LEBBL30x30	● 30 x 30	30	30	1,9	0,6	
LEBBL40x60	● 40 x 60	40	60	1,9	1,5	
LEBBL60x80	● 60 x 80	60	80	1,9	2,6	

① Sizes 30 x 30 cm and 40 x 60 cm are suitable for both wall hanging or counter use  
Size of 60 x 80 cm is suitable for wall hanging only



## WOODEN T STAND MENU HOLDER

- IT**
- Durevole legno di quercia
  - Facile da pulire
  - Si cambia il contenuto in un attimo
- ES**
- Madera de roble resistente
  - Fácil de limpiar
  - Cambia de contenido en un segundo
- FR**
- Bois de chêne durable
  - Facile à nettoyer
  - Changez de contenu en une fraction de seconde



Art. nr.	DIN/Size	Dimensions (cm)			
		W	H	D	KG
TA4PW	A4	21	32,5	6	0,5
TA5PW	A5	15	23,7	5	0,3
TA6PW	A6	10,5	17,7	4	0,2



BESTSELLER



## NATURA TABLE TOP CHALK BOARD

- IT**
  - Ideale per presentazioni speciali
  - Supporto in legno tinto
  - Scrittura e pulizia facili da eseguire
- ES**
  - Idónea para presentaciones especiales
  - Pies de madera noble tratada
  - Escritura y limpieza fácil
- FR**
  - Idéal pour la présentation d'une offre spéciale
  - Pieds en bois dur tachés
  - Ecriture et nettoyage faciles

Art. nr.	DIN/Size	Dimensions (cm)	W	H	D	KG
TCHBLBA4	A4	●	26	31,7	6	0,8
TCHBLBA5	A5	●	20	23	6	0,5
TCHBBRA4	A4	●	26	31,7	6	0,8
TCHBBRA5	A5	●	20	23	6	0,5
TCHBBLA4	A4	●	26	31,7	6	0,8
TCHBBLA5	A5	●	20	23	6	0,5

Optional: Brand with your logo



### SET OF WHITE PLASTIC LETTERS

Accessory for Black Letter Board



- IT** • Due fogli di 150 lettere
- ES** • 2 Blätter mit 150 Buchstaben
- FR** • 2 vellen van 150 letters

Art. nr. LEB-LHEAD

### CHALK MARKERS 3 MM

Accessory for all Chalk Boards and A-Boards



- IT** • Facili da pulire
- ES** • Leicht zu reinigen
- FR** • Makkelijk schoon te maken

Art. nr. CHMARK3WHITE

### CHALK MARKERS 15 MM

Accessory for all Chalk Boards and A-Boards



- IT** • Facili da pulire
- ES** • Leicht zu reinigen
- FR** • Makkelijk schoon te maken

Art. nr. CHMARK15WHITE

Natura Chalk Board (p. 122/ch. 7), Black Outdoor Menu Case / LED (p. 135/ch.8)



# NAVARRA

## 8. MENU DISPLAYS

Porta Menu  
Porta Menú  
Affichages de Menu

Ideal for displaying restaurant menus and other promotional messages. Content can be changed easily. Commonly used in the hospitality sector. Products include freestanding stands, wall mounted menu boards and table top displays. Available in different sizes and colours. Optional LED lighting available.

### INDEX

8.1 Menu Displays **130**  
Espositori per menu  
Porta Menú  
Affichages de Menu

8.2 Menu Table Tops **140**  
Portamenù da tavolo  
Porta Menú de Mesa  
Présentoirs de Menus  
pour Tables

- **STURDY ALUMINIUM DESIGNS WITH AND WITHOUT LED OPTIONS**
- **PERFECT FIT FOR DIFFERENT DIN SIZES**
- **GREAT SOLUTION FOR HOSPITALITY**

✓ **GOOD**  
LOCKABLE MENU STAND  
LOGO / LED

- Functional anodised info pole
- Top card for individual logos
- Suitable for outdoor use in covered area

👍 **BETTER**  
BLACK FREESTANDING MENU POLE  
/ LED

- Lockable header
- With or without LED strips
- Indoor or covered outdoor use

🏆 **BEST**  
OUTDOOR MENU BOARD PREMIUM

- Unique premium design
- Special extra stable angular pole
- Safety glass with black ceramic graphic



## OUTDOOR MENU FRAME STAND BLACK

- IT**
- Portamenù da esterno, autoportante, in un moderno colore nero
  - Design di alto livello a un prezzo conveniente
  - Con chiusura a chiave

- ES**
- Un portamenú de pie en color negro y moderno para uso en exteriores
  - Diseño premium con un precio asequible
  - Se cierra con llave

- FR**
- Présentoir de menu pour l'extérieur, autoportant, de couleur noire moderne
  - Une conception de qualité supérieure à un prix abordable
  - Verrouillable par clé



Art. nr.	DIN/Size	Dimensions (cm)			
		W	H	D	KG
SCPF8xA4C9005	8 x A4	59,8	166	44,8	14,6

With wheels for easy mobility



**BLACK FREESTANDING MENU POLE / LED**

- IT**
  - Espositore con serratura
  - Con o senza strisce LED
  - Uso interno o esterno coperto
- ES**
  - Cabecera con cierre
  - Con o sin tiras LED
  - Para interiores y zonas exteriores cubiertas
- FR**
  - Embase verrouillable
  - Avec ou sans bandes de LED
  - Utilisation intérieure ou extérieure couverte



Art. nr.	DIN/Size	Dimensions (cm)			
		W	H	D	KG
<b>Non-illuminated</b>					
SCZNPOL4x4A4C9005	4 x A4	50	128	40	15,5
<b>Illuminated</b>					
SCZNPOL4x4A4C9005LED	4 x A4	50	128	40	15,7

ⓘ Electrical connection must be indoor or via IP rated electrical box

Lockable Menu Stand (p. 133/ch. 8) and Wooden Showcase (p. 134/ch. 8)

**BLACK LOCKABLE MENU STAND / LED**

- IT**
  - Design minimalista ed elegante
  - Vetrina in alluminio con serratura sul bordo superiore
  - Piastra a terra in acciaio pesante
- ES**
  - Diseño minimalista y elegante
  - Vitrina de aluminio con cerradura
  - Base de acero sólida
- FR**
  - Conception minimaliste élégante
  - Vitrine en aluminium, verrouillable sur le dessus
  - Plaque de sol en acier lourd



Art. nr.	DIN/Size	Dimensions (cm)			
		W	H	D	KG
<b>Non-illuminated</b>					
MBSCZN2xA4C9005	2 x A4	50,5	112,5	45	10
<b>Illuminated</b>					
MBSCZN2xA4C9005LED	2 x A4	50,5	112,5	45	10,5

ⓘ Electrical connection must be indoor or via IP rated electrical box

**LOCKABLE MENU STAND LOGO / LED**

- IT**
  - Palo informativo anodizzato funzionale
  - Espositore per loghi personalizzati
  - Adatto a un utilizzo esterno in aree coperte
- ES**
  - Poste funcional anodizado
  - Espacio para logotipo
  - Adecuado para uso en exterior cubierto
- FR**
  - Tringle d'information fonctionnelle anodisée
  - Carte supérieure pour logos individuels
  - Équipé pour une utilisation en extérieur dans une zone couverte

topcard with print now available →



Art. nr.	DIN/Size	Dimensions (cm)			
		W	H	D	KG
<b>Non-illuminated</b>					
MBSCZ2xA4	2 x A4	50,5	115	45	10,7
MBSCZ2xA4C9005	2 x A4	50,5	115	45	9,5
<b>Illuminated</b>					
MBSCZ2xA4LED	2 x A4	50,5	115	45	12,1

ⓘ Electrical connection must be indoor or via IP rated electrical box





## WOODEN SHOWCASE

- IT**
- Bacheca elegante con cornice in legno
  - Fondo nero magnetico pulibile a secco
  - Perno di chiusura facile e vintage
- ES**
- Tablón de anuncios moderno con marco de madera
  - Trasera magnética negra de borrado en seco
  - Cierre fácil de estilo vintage
- FR**
- Élégant tableau d'affichage avec cadre en bois
  - Paroi arrière magnétique noire effaçable à sec
  - Fermeture facile et vintage

Art. nr.	DIN/Size	Dimensions (cm)			
		W	H	D	KG
SCWA3	A3	30	42	3,7	1,9

- Perfect for hospitality and office
- Use chalkmarkers and magnet to write and hang your content. See p. 127/ch. 7, p. 171/ch. 10 and p. 178/ch. 11



## BLACK OUTDOOR MENU CASE / LED

- IT**
- Vetrina nera per montaggio a parete
  - Stabile struttura in alluminio con serratura
  - Pannello frontale in policarbonato
- ES**
- Vitrina negra para montaje en la pared
  - Construcción de aluminio estable con cerradura
  - Panel frontal de policarbonato
- FR**
- Vitrine noire pour montage mural
  - Structure stable en aluminium verrouillable
  - Panneau avant en polycarbonate

Art. nr.	DIN/Size	Dimensions (cm)			
		W	H	D	KG
<b>Non-illuminated</b>					
SCZN2xA4C9005	2 x A4	50,5	37,7	2,2	2,4
SCZN4xA4C9005	4 x A4	50,5	67,9	2,2	3,7
<b>Illuminated</b>					
SCZN2xA4C9005LED	2 x A4	50,5	37,7	2,2	2,7
SCZN4xA4C9005LED	4 x A4	50,5	67,9	2,2	4

- ⓘ Electrical connection must be indoor or via IP rated electrical box



## OUTDOOR MENU CASE LOGO / LED

- IT**
- Profilo in alluminio anodizzato da 37 mm
  - Perfetta davanti ai ristoranti e ai bar
  - Pannello logo per marchio personalizzato
- ES**
- Perfil de aluminio anodizado de 37 mm
  - Perfecto para la entrada de los restaurantes, bares y cafeterías
  - Panel para su logo
- FR**
- Profil en aluminium anodisé de 37 mm
  - Parfait devant les restaurants, les bars et les cafés
  - Panneau avec logo pour le marquage individuel

topcard with print now available →



- ⓘ Electrical connection must be indoor or via IP rated electrical box

## OUTDOOR MENU BOARD PREMIUM

- IT**
- Design premium unico
  - Palo angolare super stabile speciale
  - Vetro di sicurezza con grafica in ceramica nera
- ES**
- Diseño Premium especial
  - Poste angular especial extra estable
  - Cristal templado con impresión cerámica negra
- FR**
- Conception haut de gamme unique
  - Poteau angulaire spécial ultra-stable
  - Verre de sécurité avec imprimé en céramique noire



Art. nr.	DIN/Size	Dimensions (cm)			
		W	H	D	KG
MBSCEOSA2LED	A2	73,7	138,4	58	32,1
MBSCEOSA3LED	A3	60	130,3	58	13

- ⓘ Weather resistant (IP56)
- ⓘ Electrical connection must be indoor or via IP rated electrical box

## A2 MENU BOARD DESIGN STANDARD

- IT**
- Cornice a scatto angolata con bordi squadriati o arrotondati
  - Design estetico
  - Base in MFC con 4 piedini in gomma per una maggiore stabilità
- ES**
- Marco con esquinas redondeadas o unidas en inglete
  - Diseño bonito
  - Base de MFC con 4 patas de goma para mejor estabilidad
- FR**
- Cadre clic-clac avec coins biseautés ou ronds
  - Conception esthétique
  - Base MFC avec 4 pieds en caoutchouc pour une plus grande stabilité



Art. nr.	Corner shape	DIN/Size	Dimensions (cm)			
			W	H	D	KG
MBA2R25	Rounded	A2	62,5	110	39,1	8,5
MBA2G25	Mitred	A2	62,5	110	39,1	8,5

## MENU BOARD STICK-ON

- IT**
- Palo in alluminio e base in acciaio
  - Materiale robusto e resistente alle intemperie (BOND)
  - L'Omni Velcro incluso per fissare pannelli di ogni materiale
- ES**
- Poste de aluminio y base de acero
  - Tablero duradero y resistente a la intemperie (BOND)
  - Incluye Omni Velcro para sujetar cualquier material en el tablero
- FR**
- Mât en aluminium et base en acier
  - Panneau robuste et résistant aux intempéries (BOND)
  - Omni Velcro inclus pour maintenir des panneaux de divers matériaux

Art. nr.	Icon	DIN/Size	Dimensions (cm)			
			W	H	D	KG
MBSO-HW		-	33	101,2	33	3,4
+ FBA4GV-BW3P	□	A4	21	27	0,5	0,3
+ FBA3GV-BW3P	□	A3	29,7	42	0,5	0,6
+ FBA2GV-BW3P	□	A2	42	59,4	0,5	1,1
+ FB50x70GV-BW3P	□	50 x 70	50	70	0,5	1,6
+ FBA4GV-BW3L	□	A4	27	21	0,5	3,4
+ FBA3GV-BW3L	□	A3	42	29,7	0,5	0,3
+ FBA2GV-BW3L	□	A2	59,4	42	0,5	0,6
+ FB50x70GV-BW3L	□	50 x 70	70	50	0,5	1,1

- ⓘ For indoor and covered outdoor use



### A4/A3 MENU BOARD DESIGN COMPASSO®

- IT**
  - Design Unico Cornice a Scatto Compasso®
  - Durata estrema
  - Resa estetica
- ES**
  - Diseño único de marco abatible Compasso®
  - Gran durabilidad
  - Look elegante
- FR**
  - Conception unique du cadre clic-clac Compasso®
  - Résistance extrême
  - Aspect esthétique



Art. nr.	DIN/Size	Dimensions (cm)			
		W	H	D	KG
MBA3G37	A3	35,1	111	40,5	8,8
MBA4G37	A4	35,1	111	40,5	6,3

### A4/A3 MENU BOARD DESIGN STANDARD

**BESTSELLER**

- IT**
  - Palo in alluminio angolato con classica Cornice a Scatto
  - Base: MFC (argento) o base in acciaio (nero)
  - Copertura locandina stabile ai raggi UV e antiriflesso
- ES**
  - Un poste de aluminio con marco abatible
  - Base: MFC (plata) o base de acero (negro)
  - Frontal anti-UV y antirreflejos
- FR**
  - Poteau en aluminium incliné avec cadre clic-clac classique
  - Base: MFC (argent) o base en acier (noir)
  - Film antireflet résistant aux UV



Art. nr.	Corner shape	DIN/Size	Dimensions (cm)			
			W	H	D	KG
MBA3G25	Mitred	A3	33	110	39,1	5,5
MBA3R25	Rounded	A3	33	110	39,1	5,5
MBA4G25	Mitred	A4	30	108	29,2	2,8
MBA4R25	Rounded	A4	30	108	29,2	2,7
MBA3G25C9005	Mitred	A3	33	110	39,1	5,5
MBA4G25C9005	Mitred	A4	30	108	29,2	2,8

See chapter 1. Poster Frames and Displays for more displays (p. 14)

Natura Chalk A-Board Classic (p. 121/ch. 7) and A4/A3 Menu Board Design Standard (p. 139/ch. 8)

### RINGBINDER MENU STAND

- IT**
  - Costruito con Raccoglitore ad anelli per circa 200 pagine in A4
  - Può essere personalizzato con l'opzione pannello per il logo
  - Base quadrata con gommini
- ES**
  - Anillas interreceptáculos de capacidad de hasta 200 páginas de formato DIN A4
  - Apropiado para branding con panel superior para su logotipo o marca
  - Base cuadrada con goma
- FR**
  - Equipé d'un Ringbinder pour environ 200 pages A4
  - Adapté au branding avec panneau pour logo en option
  - Base carrée avec caoutchouc



Art. nr.	DIN/Size	Dimensions (cm)			
		W	H	D	KG
MBCLIP2xA4	2 x A4	48,9	107	45	8,4

Round base on request

138 See chapter 1. Poster Frames and Displays for more displays (p. 14)



### SCRITTO® L MENU STAND

- IT**
  - In polipropilene durevole
  - Rapida sostituzione del contenuto
  - Espositore porta menù da tavolo ideale
- ES**
  - Fabricado en polipropileno duradero
  - Cambio de contenido rápido
  - Display de mesa ideal
- FR**
  - Réalisé en polypropylène résistant
  - Remplacement rapide du contenu
  - Présentoir de table idéal



Art. nr.	DIN/Size	Dimensions (cm)				KG
		W	H	D		
LA5PBLACK	A5	16,1	23,5	5,5	0,2	
LA6PBLACK	A6	11,8	17	5,5	0,1	

### SCRITTO® T MENU STAND

- IT**
  - In polipropilene durevole
  - Rapida sostituzione del contenuto
  - Espositore porta menù da tavolo ideale
- ES**
  - Fabricado en polipropileno duradero
  - Cambio de contenido rápido
  - Display de mesa ideal
- FR**
  - Remplacement rapide du contenu
  - Présentoir de table idéal ervangen
  - Ideaal als tafeldisplay



Art. nr.	DIN/Size	Dimensions (cm)				KG
		W	H	D		
TA5PBLACK	A5	16,1	23,5	5,5	0,2	
TA6PBLACK	A6	11,8	17	5,5	0,1	

### MENU CARD HOLDER

- IT**
  - Effetto Premium
  - Base convessa in alluminio anodizzato argento
  - Fogli facili da inserire
- ES**
  - Look Premium
  - Forma de base convexa de aluminio anodizado en plata
  - Fácil inserción de hojas
- FR**
  - Look Premium
  - Base convexe en aluminium argenté anodisé
  - Insertion simple des feuilles



Art. nr.	DIN/Size	Dimensions (cm)				KG
		W	H	D		
MCHXA5V	1 x A5	14,8	22,1	8,4	0,3	
MCHXA4V	1 x A4	21	30,8	8,4	0,5	
MCHXA5H	1 x A5	21	15,9	8,4	0,3	
MCHXA4H	1 x A4	29,7	22,1	8,4	0,5	

### T STAND LED

- IT**
  - Display da tavolo illuminato con autonomia di 8-10 con una sola carica
  - Disponibile in bianco o nero e nei formati DIN A5 e DL
  - Protezione in plastica per i poster
- ES**
  - Exhibidor de mesa iluminado con hasta 8-10 horas de duración por carga
  - Elija entre negro o blanco y tamaños DIN A5 y DL
  - Cubierta de plástico para proteger el cartel
- FR**
  - Le porte affiche de table lumineux possède une durée de 8 à 10 heure en une seule charge
  - Disponible en noir ou en blanc et aux formats DIN A5 et DL
  - Pochette en plastique pour protéger le visuel



Art. nr.	DIN/Size	Dimensions (cm)				KG
		W	H	D		
TDLPWHITELED	DL	11,7	24	6	0,3	
TA5PWHITELED	A5	16	24	6	0,4	
TDLPBLACKLED	DL	11,7	24	6	0,3	
TA5PBLACKLED	A5	16	24	6	0,4	

**L STAND**

- IT**
- In acrilico trasparente
  - Duraturo e preciso
  - Opzione stampa serigrafica del logo su richiesta
- ES**
- Acrílico transparente
  - Duradero y preciso
  - Posibilidad de solicitar serigrafía de su logo bajo petición
- FR**
- Acrylique clair
  - Résistant et précis
  - Option d'impression du logo sur le présentoir à la demande



Art. nr.	Icon	DIN/Size	Dimensions (cm)			
			W	H	D	KG
LA6PXV	□	A6	10,5	14,6	5,6	0,1
LA5PXV	□	A5	14,8	20,3	7,7	0,2
LA4PXV	□	A4	21	28,7	10,7	0,3
LA3PXV	□	A3	29,7	40,3	15,1	0,9
LA6PXS	□	A6	14,8	10,5	4,1	0,1
LA5PXS	□	A5	21	14,6	5,6	0,2
LA4PXS	□	A4	29,7	20,3	7,7	0,3



**T STAND**

- IT**
- Duraturo e preciso
  - Di facile utilizzo
  - In formato orizzontale o verticale
- ES**
- Acrílico transparente
  - Fácil de usar
  - Formato vertical u horizontal
- FR**
- Acrylique plié clair
  - Simple à utiliser
  - Format portrait ou paysage



Art. nr.	Icon	DIN/Size	Dimensions (cm)			
			W	H	D	KG
TA7PXV	□	A7	7,4	10,9	5,5	0,1
TA6PXV	□	A6	10,5	15,2	5,5	0,1
TA5PXV	□	A5	14,8	21,4	6,5	0,2
TA4PXV	□	A4	21	30,2	5,5	0,3
TA3PXV	□	A3	29,7	42,5	5,5	0,9
TA7PXS	□	A7	10,5	7,9	6,5	0,1
TA6PXS	□	A6	14,8	10,9	6,5	0,1
TA5PXS	□	A5	21	15,2	6,5	0,2
TA4PXS	□	A4	29,7	21,4	6,5	0,4



**SCRITTO® L STAND**

**BESTSELLER**

- IT**
- Duraturo e preciso
  - Opzione stampa serigrafica del logo su richiesta
  - In formato orizzontale o verticale
- ES**
- Duradero y preciso
  - Posibilidad de solicitar serigrafía de su logo bajo petición
  - Formato vertical u horizontal
- FR**
- Résistant et précis
  - Option d'impression du logo sur le présentoir à la demande
  - Format portrait ou paysage



Art. nr.	Icon	DIN/Size	Dimensions (cm)			
			W	H	D	KG
LA4P	□	A4	21,4	29,2	10	0,3



**SCRITTO® T STAND**

- IT**
- In polistirolo trasparente
  - Duraturo e preciso
  - Di facile utilizzo
- ES**
- Fabricado de poliestireno transparente
  - Duradero y preciso
  - Fácil de usar
- FR**
- Réalisé en polystyrène clair
  - Résistant et précis
  - Simple à utiliser



Art. nr.	Icon	DIN/Size	Dimensions (cm)			
			W	H	D	KG
TA5P	□	A5	16,2	24,9	6	0,2
TA4P	□	A4	22,5	34,5	7	0,5



**A STAND**

- IT**
- In acrilico trasparente ripiegato
  - Fogli informativi facili da sostituire
  - In formato orizzontale o verticale
- ES**
- Acrílico transparente doblado
  - Fácil de cambiar la hoja de información
  - Formato vertical u horizontal
- FR**
- Acrylique plié clair
  - Changement simple de la feuille d'information
  - Format portait ou paysage



Art. nr.		DIN/Size	Dimensions (cm)			
			W	H	D	KG
AA7PXS		A7	10,5	7,7	3,7	0,1
AA6PXS		A6	14,8	10,9	5,1	0,1
AA5PXS		A5	21	15,1	6,9	0,4
AA4PXS		A4	29,7	21,1	9,6	0,5

**ROLL-BANNER MINI**

- IT**
- Alternativa originale a un cartello informativo
  - Design minimalista e accattivante
  - Cassetta con tappi laterali cromati
- ES**
- Alternativa original a un letrero de información
  - Diseño minimalista y llamativo
  - Base con tapas laterales cromadas
- FR**
- Alternative originale à un poster d'information
  - Conception minimaliste et accrocheuse
  - Casette avec cache latéral chromé

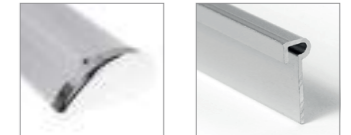

Art. nr.	DIN/Size	Dimensions (cm)		
		W	H	KG
RBMA4	A4	21	29,7	0,4
RBMA3	A3	29,7	42	0,5

Graphic available

**MAGNETIC T-STAND / TICKET HOLDER**

- IT**
- Design Premium con una base spessa 8 mm
  - Facile accesso - connessione pannello magnetico
  - Con o senza base
- ES**
- Diseño Premium con la base de 8 mm de grosor
  - Acceso fácil- panel de conexión magnética
  - Con o sin base
- FR**
- Conception Premium avec base de 8 mm
  - Accès simple - fixation par panneau magnétique
  - Avec ou sans base



Art. nr.		DIN/Size	Dimensions (cm)			
			W	H	D	KG
MAHTA5P		1 x A5	14,9	21,9	4	0,4
MAHTA4P		1 x A4	21,1	30,6	5	0,8
MAHA7		1 x A7	7,5	10,6	1,6	0,3
MAHA6		1 x A6	10,6	14,9	1,6	0,4



## 9. OUTDOOR EQUIPMENT

Prodotti per uso esterno  
Equipamiento para Exterior  
Équipement Extérieur

Outdoor equipment is the solution for every audience at the right time. Durable and weather resistant solutions for every outdoor activity and promotion. A great variety of products. Commonly used in the hospitality, office, retail and event markets.

### INDEX

9.1 Outdoor Equipment **148**  
*Prodotti per uso esterno*  
*Equipamiento para Exterior*  
*Équipement Extérieur*

- FREESTANDING AND WALL MOUNTING OPTIONS
- VARIOUS DESIGNS TO SUIT A WIDE RANGE OF MARKETS
- EASY AND QUICK TO INSTALL

## ROUNDED BIN

- IT**
- Cestino della spazzatura da pavimento in acciaio
  - Inserto posacenere in acciaio inox
  - Facile da aprire e da pulire
- ES**
- Papelera de acero independiente
  - Tapa superior con cenicero de acero inoxidable
  - Fácil de abrir y limpiar
- FR**
- Poubelle sur pied en acier
  - Dessus de cendrier en acier inoxydable
  - Facile à ouvrir et à nettoyer



Art. nr.	Dimensions (cm)			
	W	H	D	KG
SMCSS	25	60	25	4,3

## SMOKING TABLE FREESTANDING

- IT**
- Resistente alle intemperie e agli incendi
  - Base in acciaio inox resistente
  - Completamente assemblato e pronto all'uso
- ES**
- Resistente a la intemperie y las quemaduras
  - Base de acero inoxidable de gran resistencia
  - Montada y lista para usar
- FR**
- Résistant aux intempéries et au feu
  - Base en acier inoxydable pour utilisation intensive
  - Entièrement assemblée et prête à l'emploi



Art. nr.	DIN/Size	Dimensions (cm)			
		W	H	D	KG
SMT70X110	105,5 x 29,7 cm	70	118,3	70	33,8

## RECTANGULAR ASHTRAY

- IT**
- Struttura rettangolare da fissare alla parete
  - Finitura in alluminio spazzolato
  - Con chiusura di sicurezza per evitare l'uso improprio
- ES**
- Construcción rectangular para montaje en pared
  - Acabado en aluminio pulido
  - Con cerradura de seguridad contra el uso indebido
- FR**
- Construction rectangulaire pour montage mural
  - Finition en aluminium brossé
  - Verrou de sécurité contre toute utilisation abusive



Art. nr.	Dimensions (cm)			
	W	H	D	KG
SMWS	8	48	10,8	1,7

## CYLINDRICAL ASHTRAY

- IT**
- Aspetto sottile cilindrico
  - Facile da fissare alla parete
  - Spazzola inclusa per una facile pulizia
- ES**
- Aspecto cilíndrico y fino
  - Fácil montaje en la pared
  - Cepillo de limpieza incluido
- FR**
- Aspect cylindrique fin
  - Fixation murale facile
  - Brosse incluse pour un nettoyage facile



Art. nr.	Dimensions (cm)			
	W	H	D	KG
SMWR	8	48	10,8	1,3

**BESTSELLER**

### CYLINDRICAL ASHTRAY POST STAINLESS STEEL

- IT**
- Posacenere in acciaio inox da terra
  - Chiusura di sicurezza protettiva
  - Fori preimpostati per fissaggio a terra

- ES**
- Cenicero de pie de acero inoxidable
  - Cerradura de seguridad para protección
  - Orificios de fijación para instalación

- FR**
- Cendrier en acier inoxydable sur pied
  - Verrou de sécurité pour la protection
  - Trous prépercés pour une fixation au sol



Art. nr.	Dimensions (cm)			
	W	H	D	KG
SMPSS	18	90	18	7,5

### FREESTANDING ASHTRAY

- IT**
- Posacenere da terra con struttura in acciaio
  - Accesso da quattro lati
  - Design antivandalismo

- ES**
- Cenicero de pie con construcción de acero
  - Acceso por las cuatro caras
  - Diseño antivandálico

- FR**
- Cendrier sur pied en acier
  - Accès des quatre côtés
  - Conception anti-vandalisme



Art. nr.	Dimensions (cm)			
	W	H	D	KG
SMPBL	21	120	21	10,8

### FREESTANDING ASHTRAY WITH BIN

- IT**
- Posacenere da terra con struttura in acciaio
  - Combinazione posacenere e cestino
  - Di colore nero elegante

- ES**
- Cenicero de pie con construcción de acero
  - Cenicero y papelera al mismo tiempo
  - Color negro elegante

- FR**
- Cendrier sur pied en acier
  - Cendrier et poubelle tout-en-un
  - Élégante couleur noire



Art. nr.	Dimensions (cm)			
	W	H	D	KG
SMRBSBL	31,5	120	31,5	12,6



# OFFICE

Ufficio  
Oficina  
Bureau



Efficient and effective: That's what matters for all visual communication products for the office industry. The diverse range of products makes it easy to create a perfectly organised, highly visible and pleasant atmosphere for sharing information.

## INDOOR/OUTDOOR LOCKABLE SHOWCASES

See 10. Lockable Notice Boards  
page 158 & 164



**OUTDOOR LOCKABLE SHOWCASE ALPHA**  
See 10. Lockable Notice Boards  
page 164



**BROCHURE HOLDERS**  
See 14. Brochure Holders  
page 198



**A4/A3 MENU BOARD DESIGN STANDARD**  
See 8. Menu Displays  
page 139



**SCRITTO® ECONOMY WHITEBOARD**  
See 11. Flipcharts and Writable Boards  
page 173



**SCRITTO® GLASSBOARD**  
See 11. Flipcharts and Writable Boards  
page 174



**BROCHURE HOLDER DESIGN STANDARD**  
See 6. Leaflet and Catalogue Holders  
page 108



topcard with print  
now available

**ALUMINIUM A-BOARDS**  
See 5. Pavement Signs  
page 88



now available  
with imprint

**WOODEN CHALK A-BOARDS**  
See 7. Wooden Signs  
page 118



**CYLINDRICAL ASHTRAY**  
See 9. Outdoor Equipment  
page 149



**WAYFINDING SYSTEM CURVED**  
See 12. Wayfinding Systems  
page 181



**GLASS SHOWCASE ILLUMINATED**  
See 13. Glass Showcases  
page 194

## interesting categories for you

1. POSTER FRAMES AND DISPLAYS	14
2. TEXTILE FRAMES	38
4. DIGITAL DISPLAYS	62
5. PAVEMENT SIGNS	86
6. LEAFLET AND CATALOGUE HOLDERS	106
7. WOODEN SIGNS	114
8. MENU DISPLAYS	128
9. OUTDOOR EQUIPMENT	146
10. LOCKABLE NOTICE BOARDS	154
11. FLIPCHARTS AND WRITABLE BOARDS	170
12. WAYFINDING SYSTEMS	178
13. GLASS SHOWCASES	192
14. BROCHURE HOLDERS	196
15. BANNERS	206
16. FLAGS	234

# 10. LOCKABLE NOTICE BOARDS

**Bacheche con serratura**  
**Tablones de anuncios con cerradura**  
**Tableaux d'affichage verrouillables**

Lockable Notice Boards are designed to keep public messages and information secure and free from tampering. A variety of anodised aluminium profiles designed for indoor and outdoor use, formats in 1 x A4 up to 27 x A4, RAL-colour options and even fire-retardant materials.

- ✦ **GUARANTEED MAXIMUM SAFETY AND ESG SAFETY GLASS PROTECTION**
- ✦ **VARIOUS OPTIONS: CORK, MAGNETIC OR PLASTIC BACKWALL**
- ✦ **INDOOR AND OUTDOOR VARIATIONS WITH OPTIONAL LED ILLUMINATION AND IP RATING**

## INDEX

10.1 Indoor Lockable Notice Boards **158**  
*Bacheche con serratura da interno*  
*Tablones de anuncios de interior con cerradura*  
*Tableaux d'affichage intérieurs avec système de verrouillage*

10.2 Outdoor Lockable Notice Boards **164**  
*Bacheche con serratura da esterno*  
*Tablones de anuncios de exterior con cerradura*  
*Tableaux d'affichage extérieurs avec système de verrouillage*



### ✓ GOOD INDOOR LOCKABLE SHOWCASE ECONOMY

- Cost efficient and durable
- Lockable hinged door with 2 keys
- Magnetic white coated steel or cork back wall

### 👍 BETTER INDOOR LOCKABLE SHOWCASE

- Suitable for indoor and sheltered outdoor areas
- High impact PS clear front panel
- Dry wipe magnetic back panel for markers and magnets

### 🏆 BEST INDOOR LOCKABLE SHOWCASE WITH SLIDING DOORS SLIM

- Sliding security glass doors
- Slim and elegant look
- Writable and for magnet use

**LOCKABLE NOTICE BOARDS**

- Available in silver anodised aluminium as standard
- Fire rated
- RAL paint colours and printed headers on request
- Lockable front panels supplied with 2 keys per lock

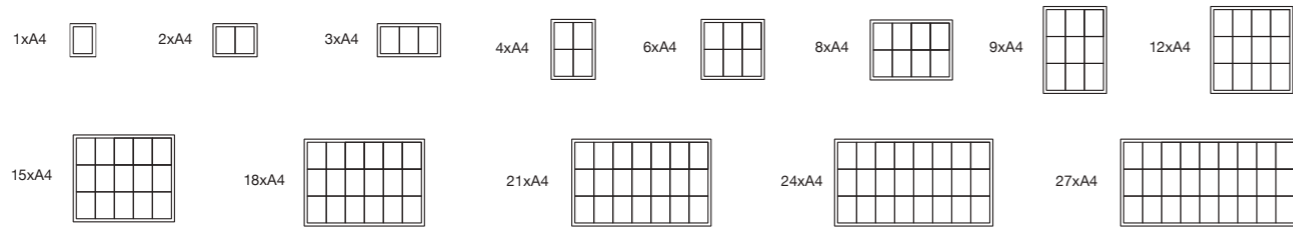

**Profiles XS**

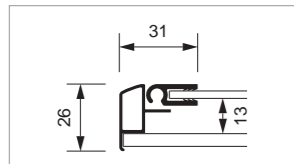

**Profiles SL**

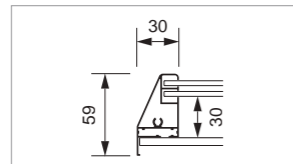

**Profiles SLG**

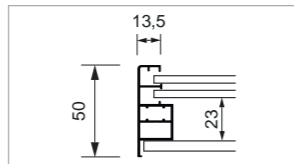

**Profiles S**

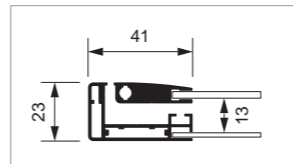
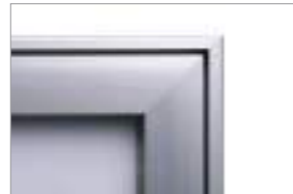

**Profiles PX**

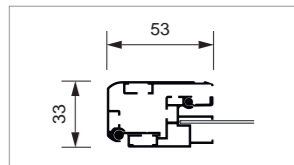

**Profiles P**

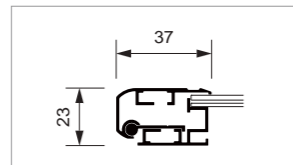

**Profiles SCA**

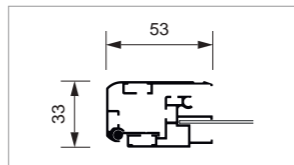

**Profiles SCG**

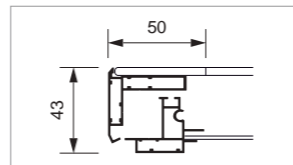

**Profiles SCEOS**

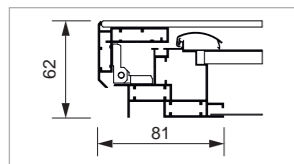

**Profiles TE**

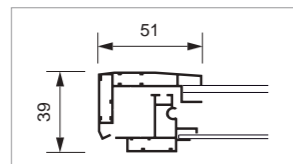

**Profiles T**

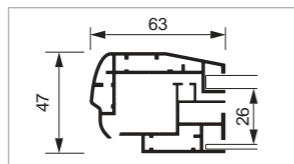

**Profiles L**

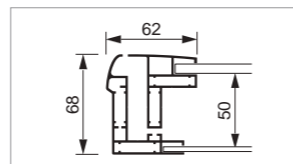

BESTSELLER



## INDOOR LOCKABLE SHOWCASE ECONOMY

- IT**
- Economica e durevole
  - Anta a battente con serratura con 2 chiavi
  - Fondo in acciaio verniciato bianco magnetico

- ES**
- Rentable y duradera
  - Puerta abisagrada con cerradura y 2 llaves
  - Trasera metálica con revestimiento magnético

- FR**
- Economique et durable
  - Porte à charnières verrouillable avec 2 clés
  - Panneau arrière magnétique en acier thermolaqué

Art. nr.	DIN/Size	Dimensions (cm)			KG
		W	H	D	
<b>Fire rated B1</b>					
SCXS1XA4B1	1 x A4	27,1	35	2,6	1,1
SCXS2XA4B1	2 x A4	49,1	35	2,6	1,6
SCXS3XA4B1	3 x A4	71,1	35	2,6	2,4
SCXS4XA4B1	4 x A4	49,1	65,5	2,6	3
SCXS6XA4B1	6 x A4	71,1	65,5	2,6	4,1
SCXS8XA4B1	8 x A4	93,1	65,5	2,6	5,3
SCXS9XA4B1	9 x A4	71,1	96,3	2,6	5,9
SCXS12XA4B1	12 x A4	93,1	96,3	2,6	7,6
SCXS1XA4	1 x A4	27,1	35	2,6	1
SCXS2XA4	2 x A4	49,1	35	2,6	1,6
SCXS3XA4	3 x A4	71,1	35	2,6	2,2
SCXS4XA4	4 x A4	49,1	65,5	2,6	2,8
SCXS6XA4	6 x A4	71,1	65,5	2,6	3,9
SCXS8XA4	8 x A4	93,1	65,5	2,6	5
SCXS9XA4	9 x A4	71,1	96,3	2,6	5,7
SCXS12XA4	12 x A4	93,1	96,3	2,6	7,3

12 mm internal depth

Art. nr.	DIN/Size	Dimensions (cm)			KG
		W	H	D	
SCXS1XA4C9005	1 x A4	27,1	35	2,6	1
SCXS2XA4C9005	2 x A4	49,1	35	2,6	1,6
SCXS3XA4C9005	3 x A4	71,1	35	2,6	2,2
SCXS4XA4C9005	4 x A4	49,1	65,5	2,6	2,8
SCXS6XA4C9005	6 x A4	71,1	65,5	2,6	3,9
SCXS8XA4C9005	8 x A4	93,1	65,5	2,6	5
SCXS9XA4C9005	9 x A4	71,1	96,3	2,6	5,7
SCXS12XA4C9005	12 x A4	93,1	96,3	2,6	7,3



## CORK INDOOR LOCKABLE SHOWCASE ECONOMY

- IT**
- Pannello frontale in acrilico
  - Fissa facilmente i messaggi sulla bacheca di sughero
  - Anteriore con porta a battente con vetro plexi

- ES**
- Panel frontal acrílico
  - Fija los mensajes fácilmente en el tablero de corcho
  - Frontal con puerta abatible con plexi glass

- FR**
- Plaque frontale en acrylique
  - Fixez facilement vos messages sur le tableau en liège
  - Façade à porte battante avec vitrage en plexi



Art. nr.	DIN/Size	Dimensions (cm)			KG
		W	H	D	
SCXSC4XA4	4 x A4	49,1	65,5	2,6	3,4
SCXSC6XA4	6 x A4	71,1	65,5	2,6	4,6
SCXSC8XA4	8 x A4	93,1	65,5	2,6	5,7
SCXSC9XA4	9 x A4	71,1	96,3	2,6	6,4
SCXSC12XA4	12 x A4	93,1	96,3	2,6	8



## INDOOR LOCKABLE SHOWCASE WITH SLIDING DOORS

- IT**
- Profundità: 30 mm
  - Ignifuga
  - Porte scorrevoli in cristallo temperato anti-impatti di 4 mm con serratura

- ES**
- Profundidad: 30 mm
  - Ignífuga
  - Puertas correderas de cristal templado anti-impactos de 4 mm con cerradura

- FR**
- Profondeur interne de 30 mm
  - Résistance au feu
  - Panneaux avant coulissants en verre de sécurité trempé transparent de 4 mm verrouillables

Art. nr.	DIN/Size	Dimensions (cm)			KG
		W	H	D	
SCSL6xA4	6 x A4	72	67,5	5,9	10,6
SCSL8xA4	8 x A4	94	67,5	5,9	12,4
SCSL9xA4	9 x A4	72	98,2	5,9	13,4
SCSL10xA4	10 x A4	116	67,5	5,9	14,8
SCSL12xA4	12 x A4	94	98,2	5,9	17,4
SCSL15xA4	15 x A4	116	98,2	5,9	20,8
SCSL18xA4	18 x A4	138	98,2	5,9	24,4
SCSL21xA4	21 x A4	160	98,2	5,9	28,2
SCSL24xA4	24 x A4	181,5	98,2	5,9	31,8

- Ideal for schools
- With safety corners





## INDOOR LOCKABLE SHOWCASE WITH SLIDING DOORS SLIM

- IT**
- Ante in vetro di sicurezza scorrevoli
  - Aspetto sottile ed elegante
  - Magnetica
- ES**
- Puertas correderas de cristal templado
  - Diseño fino y elegante
  - Para uso de imanes
- FR**
- Portes coulissantes en verre de sécurité
  - Aspect fin et élégant
  - Utilisable avec aimant

Art. nr.	DIN/Size	Dimensions (cm)			
		W	H	D	KG
SCSLG6xA4	6 x A4	68,6	64,1	5	10,6
SCSLG8xA4	8 x A4	90,6	64,1	5	12,4
SCSLG10xA4	10 x A4	112,6	64,1	5	14,8
SCSLG12xA4	12 x A4	90,6	94,8	5	17,4
SCSLG15xA4	15 x A4	112,6	94,8	5	20,8
SCSLG18xA4	18 x A4	134,6	94,8	5	24,4
SCSLG21xA4	21 x A4	156,6	94,8	5	28,2
SCSLG24xA4	24 x A4	178,1	94,8	5	31,8
SCSLG6xA4C7016JS	6 x A4	68,6	64,1	5	10,6
SCSLG8xA4C7016JS	8 x A4	90,6	64,1	5	12,4
SCSLG10xA4C7016JS	10 x A4	112,6	64,1	5	14,8
SCSLG12xA4C7016JS	12 x A4	90,6	94,8	5	17,4
SCSLG15xA4C7016JS	15 x A4	112,6	94,8	5	20,8
SCSLG18xA4C7016JS	18 x A4	134,6	94,8	5	24,4
SCSLG21xA4C7016JS	21 x A4	156,6	94,8	5	28,2
SCSLG24xA4C7016JS	24 x A4	178,1	94,8	5	31,8



## INDOOR LOCKABLE SHOWCASE WITH SLIDING DOORS SLIM WITH SAFETY CORNERS

- IT**
- Ante in vetro di sicurezza scorrevoli da 4 mm (ESG)
  - Con angolari in plastica arrotondati ABS per la sicurezza
  - Per utilizzo interno certificata B1
- ES**
- Puertas correderas de cristal templado de 4 mm (ESG)
  - Esquinas redondeadas de plástico ABS para mayor seguridad
  - Para uso en interiores Certificado B1
- FR**
- Portes coulissantes en verre de sécurité de 4 mm (ESG)
  - Coins arrondis en plastique ABS pour la sécurité
  - Pour un usage intérieur certifié B1

Art. nr.	DIN/Size	Dimensions (cm)			
		W	H	D	KG
SCSLR6xA4	6 x A4	68,6	64,1	5	8,7
SCSLR8xA4	8 x A4	90,6	64,1	5	11
SCSLR10xA4	10 x A4	112,6	64,1	5	13,4
SCSLR12xA4	12 x A4	90,6	94,8	5	15,5
SCSLR15xA4	15 x A4	112,6	94,8	5	18,7
SCSLR18xA4	18 x A4	134,6	94,8	5	22
SCSLR21xA4	21 x A4	156,6	94,8	5	25,2
SCSLR24xA4	24 x A4	178,1	94,8	5	28,4

With safety corners



BESTSELLER



## INDOOR LOCKABLE SHOWCASE

- IT**
- Adatto per aree interne ed esterne riparate
  - Pannello frontale trasparente in polistireno antiurto
  - Pannello posteriore magnetico pulibile a secco per pennarelli e magneti
- ES**
- Apropiada para uso interior y zonas exteriores cubiertas
  - Panel frontal de poliestireno transparente de gran impacto
  - Panel magnético que permite escribir con rotuladores y uso de imanes
- FR**
- Convient aux espaces intérieurs et extérieurs abrités
  - Panneau avant transparent PS à fort impact
  - Panneau arrière magnétique effaçable à sec pour marqueurs et aimants

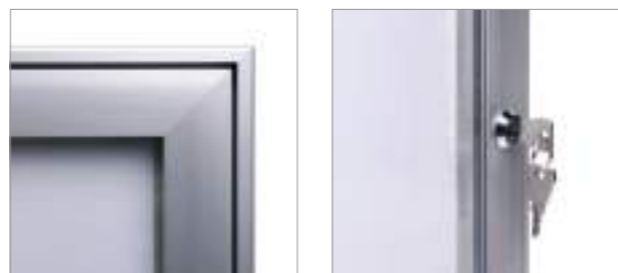

Art. nr.	DIN/Size	Dimensions (cm)			KG
		W	H	D	
<b>Fire rated B1</b>					
SCS2xA4B1	2 x A4	52,1	38,8	2,3	3
SCS3xA4B1	3 x A4	74,1	38,8	2,3	4,4
SCS4xA4B1	4 x A4	52,1	69,6	2,3	4,8
SCS6xA4B1	6 x A4	74,1	69,6	2,3	6,9
SCS8xA4B1	8 x A4	96,1	69,6	2,3	7,9
SCS9xA4B1	9 x A4	74,1	100,4	2,3	9,6
SCS12xA4B1	12 x A4	96,9	100,4	2,3	10,7
SCS2xA4	2 x A4	52,1	38,8	2,3	3
SCS3xA4	3 x A4	74,1	38,8	2,3	3,6
SCS4xA4	4 x A4	52,1	69,6	2,3	4,7
SCS6xA4	6 x A4	74,1	69,6	2,3	6,8
SCS8xA4	8 x A4	96,1	69,6	2,3	7,7
SCS9xA4	9 x A4	74,1	100,4	2,3	9,3
SCS12xA4	12 x A4	96,9	100,4	2,3	10,4

Art. nr.	DIN/Size	Dimensions (cm)			KG
		W	H	D	
SCS2xA4C9005	2 x A4	52,1	38,8	2,3	3
SCS3xA4C9005	3 x A4	74,1	38,8	2,3	4,4
SCS4xA4C9005	4 x A4	52,1	69,6	2,3	4,8
SCS6xA4C9005	6 x A4	74,1	69,6	2,3	6,9
SCS8xA4C9005	8 x A4	96,1	69,6	2,3	7,9
SCS9xA4C9005	9 x A4	74,1	100,4	2,3	9,6
SCS12xA4C9005	12 x A4	96,9	100,4	2,3	10,7
SCS2xA4C7016JS	2 x A4	52,1	38,8	2,3	3
SCS3xA4C7016JS	3 x A4	74,1	38,8	2,3	3,6
SCS4xA4C7016JS	4 x A4	52,1	69,6	2,3	4,7
SCS6xA4C7016JS	6 x A4	74,1	69,6	2,3	6,8
SCS8xA4C7016JS	8 x A4	96,1	69,6	2,3	7,7
SCS9xA4C7016JS	9 x A4	74,1	100,4	2,3	9,3
SCS12xA4C7016JS	12 x A4	96,9	100,4	2,3	10,4

## LOCKABLE POSTER CASE ECONOMY

BESTSELLER

- IT**
- Bachecca con serratura che offre una maggiore sicurezza
  - Resistente agli urti
  - Profilo da 37 mm con fondo in plastica
- ES**
- Un Portaposter con el cierre de seguridad mejorado
  - Resistente al impacto
  - Perfil de 37 mm con pared posterior de plástico
- FR**
- Boîtier pour poster verrouillable avec sécurité renforcée
  - Résistant aux chocs
  - Profil 37 mm, porte en polycarbonate



Art. nr.	DIN/Size	Dimensions (cm)			KG
		W	H	D	
SCPA4	A4	26,6	35,3	2,3	1,5
SCPA3	A3	35,3	47,6	2,3	2
SCPA2	A2	47,6	65	2,3	2,8
SCPA1	A1	65	89,7	2,3	4,2
SCPA0	A0	89,7	124,5	2,3	6,6
SCP50x70	50 x 70	55,6	75,6	2,3	3,4
SCP70x100	70 x 100	75,6	105,6	2,3	5,2



**OUTDOOR LOCKABLE SHOWCASE ALPHA**

- IT**
  - Per uso esterno coperto
  - Con fondo magnetico bianco
  - Profondità interna 12 mm
- ES**
  - Para uso al aire libre cubierto
  - Con trasera magnética de color blanco
  - Profundidad: 12 mm
- FR**
  - Pour une utilisation extérieure couverte
  - Avec paroi arrière magnétique blanche
  - Profondeur interne de 12 mm



Art. nr.	DIN/Size	Dimensions (cm)			
		W	H	D	KG
SCA4xA4	4 x A4	54,9	72,3	3,3	5,5
SCA6xA4	6 x A4	76,4	72,3	3,3	8,1
SCA8xA4	8 x A4	98,1	72,3	3,3	10,7
SCA9xA4	9 x A4	76,4	102,5	3,3	11,1
SCA12xA4	12 x A4	97,9	102,5	3,3	11,9
SCA15xA4	15 x A4	119,4	102,5	3,3	13,2
SCA18xA4	18 x A4	140,9	102,5	3,3	15,1

3 mm safety PETG door

**OUTDOOR LOCKABLE SHOWCASE SLIM**

- IT**
  - Certificato IP56, completamente resistente agli agenti atmosferici
  - Aspetto sottile ed elegante
  - Con fondo magnetico bianco
- ES**
  - Certificación IP56 de resistencia a la intemperie
  - Diseño fino y elegante
  - Con trasera magnética de color blanco
- FR**
  - Certifiée IP56 entièrement résistante aux intempéries
  - Aspect fin et élégant
  - Avec paroi arrière magnétique blanche



Art. nr.	DIN/Size	Dimensions (cm)			
		W	H	D	KG
SCTE4xA4PH	4 x A4	53	70,5	4	9,3
SCTE6xA4PH	6 x A4	75	70,5	4	12,7
SCTE8xA4PH	8 x A4	97	70,5	4	15,6
SCTE9xA4PH	9 x A4	75	101,2	4	16,7
SCTE12xA4PH	12 x A4	97	101,2	4	19,4
SCTE4xA4PH C7016JS	4 x A4	53	70,5	4	9,3
SCTE6xA4PH C7016JS	6 x A4	75	70,5	4	12,7
SCTE8xA4PH C7016JS	8 x A4	97	70,5	4	15,6
SCTE9xA4PH C7016JS	9 x A4	75	101,2	4	16,7
SCTE12xA4PH C7016JS	12 x A4	97	101,2	4	19,4

Other sizes and colours on request

**BESTSELLER**



black c9005

anthracite c7016js

**OUTDOOR LOCKABLE SHOWCASE**

- IT**
  - bacheca esterna bestseller con durata estrema
  - Certificato IP56, completamente resistente agli agenti atmosferici
  - Certificato di resistenza al fuoco B1 DIN 4102
- ES**
  - Vitrina para exteriores extremadamente duradera y la más vendida
  - Certificación IP56 de resistencia a la intemperie
  - Certificación de protección ignífuga B1 DIN 4102
- FR**
  - Vitrine d'affichage pour extérieur la plus vendue avec une durabilité extrême
  - Certifiée IP56 entièrement résistante aux intempéries
  - Certificat de protection incendie B1 DIN 4102

Art. nr.	DIN/Size	Dimensions (cm)			
		W	H	D	KG
SCT4xA4PH	4 x A4	58,3	76	4,7	10,3
SCT6xA4PH	6 x A4	80,5	76	4,7	14,1
SCT8xA4PH	8 x A4	102,5	76	4,7	17,3
SCT9xA4PH	9 x A4	80,5	106,7	4,7	18,6
<b>With gas spring</b>					
SCT12xA4PH	12 x A4	102,5	106,7	4,7	21,6
SCT15xA4PH	15 x A4	124,5	106,7	4,7	26,6
SCT18xA4PH	18 x A4	146,5	106,7	4,7	31,3
SCT21xA4PH	21 x A4	168,5	106,7	4,7	34,2
SCT24xA4PH	24 x A4	192,5	106,7	4,7	37,2
SCT27xA4PH	27 x A4	212,5	106,7	4,7	45,1

- Available in LED version with Outdoor Lockable Showcase Illuminated Logo
- Available in other RAL colours on request (blue, red, black, white)
- Optional: Posts and Feet (see p. 169)

Art. nr.	DIN/Size	Dimensions (cm)			
		W	H	D	KG
SCT9xA4PHC9005	9 x A4	80,5	106,7	4,7	18,6
<b>With gas spring</b>					
SCT12xA4PHC9005	12 x A4	102,5	106,7	4,7	21,6
SCT15xA4PHC9005	15 x A4	124,5	106,7	4,7	26,6
SCT18xA4PHC9005	18 x A4	146,5	106,7	4,7	31,3
SCT4xA4PHC7016JS	4 x A4	58,3	76	4,7	10,3
SCT6xA4PHC7016JS	6 x A4	80,5	76	4,7	14,1
SCT8xA4PHC7016JS	8 x A4	102,5	76	4,7	17,3
SCT9xA4PHC7016JS	9 x A4	80,5	106,7	4,7	18,6
<b>With gas spring</b>					
SCT12xA4PHC7016JS	12 x A4	102,5	106,7	4,7	21,6
SCT15xA4PHC7016JS	15 x A4	124,5	106,7	4,7	26,6
SCT18xA4PHC7016JS	18 x A4	146,5	106,7	4,7	31,3
SCT21xA4PHC7016JS	21 x A4	168,5	106,7	4,7	34,2
SCT24xA4PHC7016JS	24 x A4	192,5	106,7	4,7	37,2
SCT27xA4PHC7016JS	27 x A4	212,5	106,7	4,7	45,1



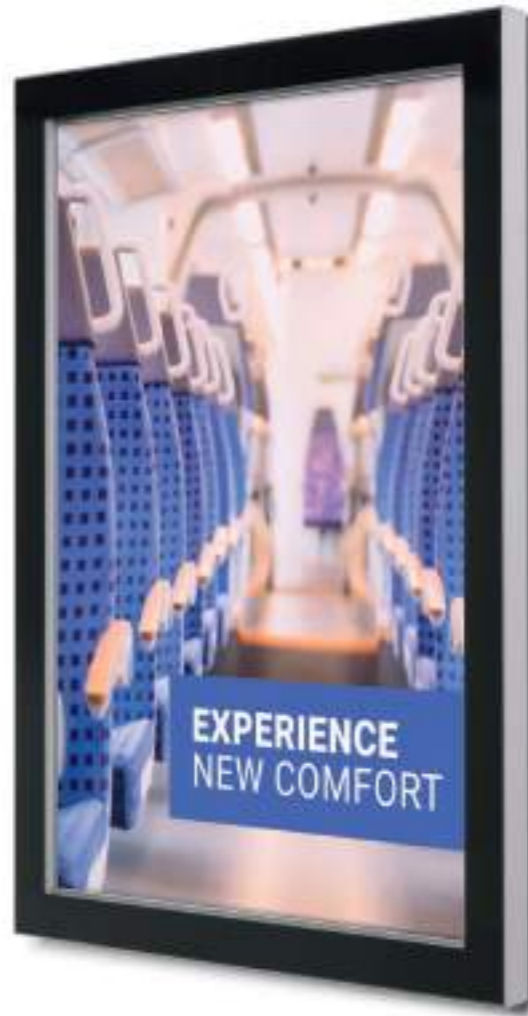

## OUTDOOR PREMIUM POSTER CASE SLIM

- IT**
- Design premium con stampa in ceramica nera sul vetro anteriore
  - Design sofisticato e sottile da 48 mm
  - Locandine sempre in ordine grazie al fondo magnetico
- ES**
- Diseño premium con una impresión de color negro en el cristal frontal
  - Diseño fino y sofisticado de 48 mm
  - Las gráficas siempre en su sitio gracias a la trasera magnética
- FR**
- Un design haut de gamme avec impression en céramique noire sur la vitre avant
  - Design raffiné et fin de 48 mm
  - Les affiches resteront à leur place grâce à la paroi arrière magnétique



Art. nr.	DIN/Size	Dimensions (cm)			KG
		W	H	D	
SCGA1	A1	92	67,3	4,5	12



## LED OUTDOOR PREMIUM POSTER CASE FREESTANDING

- IT**
- Autoportante
  - Illuminazione LED intensa 24/7
  - Bifacciale
- ES**
- Tótem porta póster
  - Iluminación LED radiante en todo momento
  - De doble cara
- FR**
- Sur pied
  - Eclairage LED 24/7
  - Double face



Art. nr.	DIN/Size	Dimensions (cm)			KG
		W	H	D	
SCEOS1200x1800DLED	120 x 180	138,4	240	22,3	145,1

- Other sizes and colours on request
- Electrical connection must be indoor or via IP rated electrical box
- 220V power cable must be prepared before installation



## OUTDOOR LOCKABLE SHOWCASE ILLUMINATED LOGO

- IT**
- Illuminata da una striscia LED da 12/14V
  - Resistente alle intemperie
  - Può essere personalizzata
- ES**
- Iluminada con tira LED 12/24V
  - Resistente a la intemperie
  - Lista para branding
- FR**
- Illuminée avec une bande de LED de 12/24 V
  - Résistante aux intempéries
  - Prête pour le marquage

topcard with print now available →



Art. nr.	DIN/Size	Dimensions (cm)			KG
		W	H	D	
SCT4xA4PHLED	4 x A4	58,5	86	4,7	13,4
SCT6xA4PHLED	6 x A4	80,5	86	4,7	19,2
SCT8xA4PHLED	8 x A4	102,5	86	4,7	22,2
SCT9xA4PHLED	9 x A4	80,5	116,7	4,7	26,6
<b>With gas spring</b>					
SCT12xA4PHLED	12 x A4	102,5	116,7	4,7	30,7
SCT15xA4PHLED	15 x A4	124,5	116,7	4,7	34,4
SCT18xA4PHLED	18 x A4	146,5	106,7	4,7	41,6
SCT21xA4PHLED	21 x A4	168,5	116,7	4,7	47,7
SCT24xA4PHLED	24 x A4	192,5	116,7	4,7	53,5
SCT27xA4PHLED	27 x A4	212,5	116,7	4,7	61,4

- IP56 certified fully weather resistant
- Other sizes and colours on request
- Electrical connection must be indoor or via IP rated electrical box

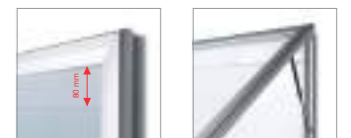

## OUTDOOR LOCKABLE SHOWCASE EXTRA DEEP

- IT**
- Profondità interna di 50 mm
  - Ideale per le medaglie o articoli simili
  - Può essere fissata al muro, alle recinzioni e applicazioni con installazione autoportante
- ES**
- Profundidad: 50 mm
  - Ideal para poner medallas u objetos similares
  - Apta para instalación en paredes, vallas y postes
- FR**
- Profondeur interne de 50 mm
  - Idéal pour exposer des médailles ou des objets similaires
  - Convient aux applications murales, de clôture et sur poteau



Art. nr.	DIN/Size	Dimensions (cm)			
		W	H	D	KG
SCL8xA4PH	8 x A4	101,2	74,7	6,8	19,2
SCL12xA4PH	12 x A4	101,2	105,4	6,8	23,5
SCL18xA4PH	18 x A4	145,2	105,4	6,8	33,6
SCL21xA4PH	21 x A4	167,2	105,4	6,8	36,6
SCL27xA4PH	27 x A4	211,5	105,4	6,8	46,4



- ⊕ Other sizes and colours on request
- ⊕ Optional: Posts and Feet (see p. 169)



## POSTS AND FEET

Accessory for Outdoor Lockable Showcase and Outdoor Lockable Showcase Extra Deep



- IT**
- Gambe in alluminio anodizzato argento con diametro da 70 mm
- ES**
- Pies de perfiles de aluminio en acabado anodizado plateado de 70 mm en diámetro
- FR**
- Pattes de profil en aluminium anodisé argent de 70 mm de diamètre

Art. nr. SCPOST  
SCPOSTP

- ⊕ Standard silver RAL paint colours available on request

## SCRITTO® STARTER KIT

Accessory for all writable Lockable Notice Boards, Whiteboards and Glassboards



- IT**
- Set di pennarelli, gomma, detergente spray e magneti
- ES**
- Set de marcadores, borrador, limpiador en spray e imanes
- FR**
- Ensemble de marqueurs, gomme à effacer, spray nettoyant et aimants

Art. nr. STARTERKIT

## SCRITTO® MAGNETS

Accessory for all Whiteboards and magnetic/writable Lockable Notice Boards



- IT**
- Set di 8 magneti, di diametro 20 mm. Disponibili in blu, rosso, bianco o nero
- ES**
- Juego de 8 imanes, 20 mm en diámetro. Disponible en colores azul, rojo, blanco o negro
- FR**
- Jeu de 8 aimants, diamètre de 20 mm. Disponible en bleu, rouge, blanc ou noir

Art. nr. MAGNETS20BLUE  
MAGNETS20RED  
MAGNETS20WHITE  
MAGNETS20BLACK



## SCRITTO® PINS

Accessory for all cork Lockable Notice Boards and Pin Boards



- IT**
- Set di 100 pz. - adatto a bacheche in feltro o in sughero
- ES**
- Contenido: 100 Uds, Para tablones de corcho o fieltro
- FR**
- Jeu de 100 pièces, adaptées aux tableaux d'affichage en liège et en feutre

Art. nr. SETPINS

## MAGNETIC POCKET

Accessory for all Lockable Notice Boards



- IT**
- Tasca in acrilico per posizionare locandine
- ES**
- Carpeta acrílica para la colocación de los posters
- FR**
- Pochette en acrylique pour placer des posters

Art. nr. SCPOCKETA4  
SCPOCKETA3

- ⊕ Great alternative to magnets

# 11. FLIPCHARTS AND WRITABLE BOARDS

**Flipcharts y Pizarras**  
**Tableaux à feuilles mobiles**  
**et tableaux inscriptibles**

Flipcharts and Writable Boards are essential communication tools for sharing information and creative concepts. Products are durable and highly functional for use in conference and meeting rooms, classrooms and other settings designed for learning and communication. Markers, magnets and other accessories available.

- **PERFECT TOOL FOR SHARING IDEAS AND SUPPORT CREATIVITY**
- **FOLDABLE FOR EASY STORAGE, EXCELLENT STABILITY**
- **GREAT SOLUTION FOR OFFICES, SCHOOLS AND MEETING ROOMS**

## INDEX

**11.1 Flipcharts 172**  
*Flipcharts*  
*Flipcharts*  
*Tableaux à feuilles mobiles*

**11.2 Whiteboards and Pin Boards 174**  
*Lavagne riscrivibili e per puntine*  
*Pizzarras Blancas y Tableros Anuncios*  
*Tableaux Blancs et Tableaux d’Affichage*

**11.3 Accessories 176**  
*Accessori*  
*Accesorios*  
*Accessoires*

### ✓ GOOD SCRITTO® CORKBOARD

- Safety corners
- Durable aluminium frame
- Honeycomb pin board

### 👍 BETTER SCRITTO® WHITEBOARD ECONOMY

- Mounting in portrait or landscape orientation
- Durable and safe construction
- Suitable for magnets and marker pens

### 🏆 BEST SCRITTO® GLASSBOARD

- Premium surface glass whiteboard
- With removable silver anodised pen tray
- Easy installation

## SCRITTO® FLIPCHART STANDARD

**BESTSELLER**

- IT**
  - Regolabile in altezza
  - Disponibile in tre opzioni; scrivibile, magnetica o a fogli
  - Dotata di portapennarelli
- ES**
  - Altura regulable
  - Tres opciones de uso; escritura, magnético o colocación de papel
  - Bandeja para rotuladores incluida
- FR**
  - Réglable en hauteur
  - Trois options utilisateur ; feuilles inscriptibles, magnétiques ou papier
  - Rangement pour feutres



Art. nr.	DIN/Size	Dimensions (cm)				
		W	H	D	KG	
FCSTN	66 x 100	89	190	82,5	12	

## SCRITTO® FLIPCHART VARIO

- IT**
  - Facile da spostare grazie alle 5 ruote
  - Regolabile in altezza fino a 2,2 m
  - Disponibile in tre opzioni; scrivibile, magnetica o a fogli
- ES**
  - Fácil de mover gracias a 5 ruedas
  - Regulable altura hasta 2,2 m
  - Tres opciones de uso; escritura, magnético o colocación de papel
- FR**
  - Facile à déplacer grâce aux 5 roues
  - Réglable en hauteur jusqu'à 2,2 m
  - Trois options utilisateur ; feuilles inscriptibles, magnétiques ou papier



Art. nr.	DIN/Size	Dimensions (cm)				
		W	H	D	KG	
FCVAS	66 x 100	70,6	220	58	15,5	
FCVAR	66 x 100	70,6	220	64	17,5	

## SCRITTO® ECONOMY WHITEBOARD

**BESTSELLER**

- IT**
  - Si può posizionare sia in orizzontale sia in verticale
  - Struttura sicura e duratura
  - Adatta a magneti e pennarelli
- ES**
  - Montaje en vertical u horizontal
  - Duradera y de construcción segura
  - Apta para imanes y rotuladores
- FR**
  - Fixation en orientation portrait ou paysage
  - Construction durable et sûre
  - Convient aux aimants et aux feutres

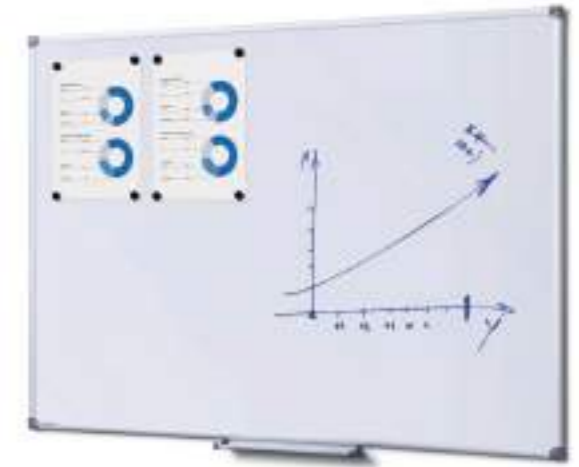

Art. nr.	DIN/Size	Dimensions (cm)				
		W	H	D	KG	
WBNECS60x45	60 x 45	60	45	1,5	2	
WBNECS90x60	90 x 60	90	60	1,5	3,6	
WBNECS90x120	90 x 120	120	90	1,5	8	
WBNECS90x180	90 x 180	180	90	1,5	12	
WBNECS100x150	100 x 150	150	100	1,5	10,5	
WBNECS100x200	100 x 200	200	100	1,5	15,5	





## SCRITTO® GLASSBOARD

- IT**
- Lavagna bianca con superficie in vetro premium
  - Con portapennarelli anodizzato argento rimovibile
  - Facile da installare
- ES**
- Superficie de cristal Premium
  - Con bandeja extraíble anodizada plata
  - Instalación fácil
- FR**
- Tableau blanc en verre de qualité
  - Avec plumier anodisé argent amovible
  - Installation facile

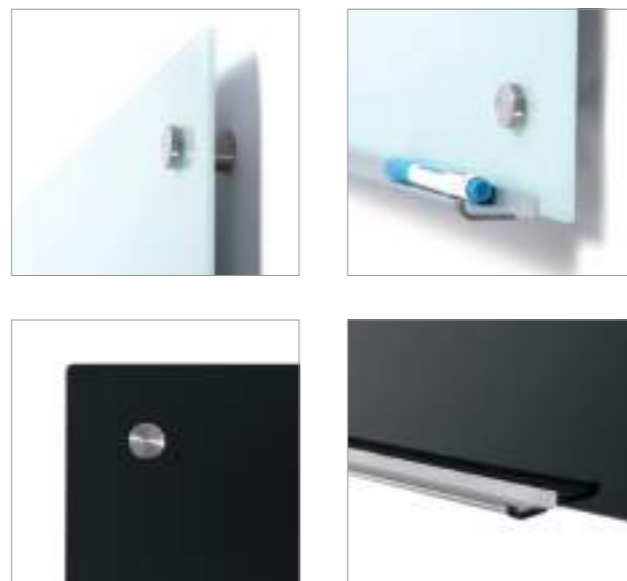

Art. nr.	DIN/Size	Dimensions (cm)				KG
		W	H	D		
WBNGB90x60	90 x 60	90	60	4	8,5	
WBNGB90x120	90 x 120	120	90	4	17	
WBNGBBL90x60	90 x 60	90	60	4	7	
WBNGBBL90x120	90 x 120	120	90	4	15	



## SCRITTO® CORKBOARD

- IT**
- Angolari di protezione
  - Cornice in alluminio duratura
  - Bachecca alveolare
- ES**
- Esquinas de seguridad
  - Marco de aluminio duradero
  - Tablón de panel para chinchetas
- FR**
- Coins de sécurité
  - Cadre en aluminium durable
  - Carte à broches Honeycomb



Art. nr.	DIN/Size	Dimensions (cm)				KG
		W	H	D		
CBN45x60	45 x 60	60	45	1,5	1,6	
CBN60x90	60 x 90	90	60	1,5	3	
CBN90x120	90 x 120	120	90	1,5	5,6	



## SCRITTO® PINS

Accessory for all Pin Boards and cork Lockable Notice Boards



- IT** • Set di 100 pz. - adatto a bacheche in feltro o in sughero
- ES** • Contenido: 100 Uds. Para tableros de corcho o fieltro
- FR** • Jeu de 100 pièces, adaptées aux tableaux d'affichage en liège et en feutre

Art. nr. SETPINS

## SCRITTO® SET OF PENS

Accessory for all Whiteboards, Glassboards and writable Lockable Notice Boards



- IT** • Un set di 4 penne; 1 colore nero, 1 blu, 1 verde e 1 rosso, per lavagne pulibili a secco
- ES** • Juego de 4 marcadores; 1x negro, 1x azul, 1x verde, 1x rojo
- FR** • Un jeu de 4 feutres : 1 noir, 1 bleu, 1 vert et 1 rouge, pour les tableaux effaçables à sec

Art. nr. SETFIXWB



## SCRITTO® WHITEBOARD ERASER

Accessory for all Whiteboards, Glassboards and writable Lockable Notice Boards



- IT** • Cancellino a secco magnetico, adatto a lavagne e prodotti pulibili a secco
- ES** • Borrador magnético para borrado en seco, para pizarras blancas u otros productos de borrado en seco
- FR** • Tampon magnétique pour effacer à sec, convient aux tableaux blancs et aux produits effaçables à sec

Art. nr. WBERASER

## SCRITTO® WHITEBOARD CLEANER

Accessory for all Whiteboards, Glassboards and writable Lockable Notice Boards



- IT** • Flacone liquido spray da 250 ml, adatto a lavagne con serratura e lavagne pulibili a secco
- ES** • Bote de spray líquido de 250 ml, para pizarras blancas con cerradura y pizarras de borrado en seco
- FR** • Flacon pulvérisateur de 250 ml, adapté aux tableaux blancs verrouillables et aux tableaux effaçables à sec

Art. nr. WBCLEANER

## SCRITTO® STARTER KIT

Accessory for all Whiteboards, Glassboards and writable Lockable Notice Boards



- IT** • Set di pennarelli, gomma, detergente spray e magneti
- ES** • Set de marcadores, borrador, limpiador en spray e imanes
- FR** • Ensemble de marqueurs, gomme à effacer, spray nettoyant et aimants

Art. nr. STARTERKIT

## SCRITTO® MAGNETS

Accessory for all magnetic Lockable Notice Boards and Whiteboards



- IT** • Set di 8 magneti, di diametro 20 mm. Disponibili in blu, rosso, bianco o nero
- ES** • Juego de 8 imanes, 20 mm en diámetro. Disponible en colores azul, rojo, blanco o negro
- FR** • Jeu de 8 aimants, diamètre de 20 mm. Disponible en bleu, rouge, blanc ou noir

Art. nr. MAGNETS20BLUE  
MAGNETS20RED  
MAGNETS20WHITE  
MAGNETS20BLACK



## 12. WAYFINDING SYSTEMS

Sistemi di orientamento  
Sistemas de Orientación  
Systèmes d'Orientation

Functional Wayfinding Systems that help guide people in the right direction. The portfolio consists of wall signage, barrier stands, belts and ropes for public guidance and managing queues. Ideal for airports, offices, hotels, museums and other public attractions.

### INDEX

12.1 Wayfinding Systems **180**  
Sistemi di orientamento  
Sistemas de Orientación  
Systèmes d'Orientation

12.2 Barriers **188**  
Barriere  
Barreras  
Barrières

- ➕ QUICK AND EASY TO ASSEMBLE
- ➕ PORTABLE PRODUCT SO EASY TO TRANSPORT AND TO PLACE
- ➕ GREAT SOLUTION FOR EVERY SITUATION

### ✓ GOOD BARRIER FLEXI BELT POST ECONOMY

- Freestanding post with 3 sided belt clip and 2,5 m belt
- Ideal for queue guidance
- Great cost value ratio

### 👍 BETTER BARRIER FLEXI BELT POST

- 2,7 m retractable tensioned belt
- Heavy base plate with good stability
- Ideal for queue guidance

### 🏆 BEST BARRIER GOLD ROPE STAND

- Antique design
- Aluminium pole with heavy steel base
- 9 kg total weight for optimal stability

## WALL MOUNTED SANDWICH PANEL

- IT**
- Elegante struttura a sandwich
  - Due facce da 3 mm in acrilico trasparente
  - Locandine nei formati da A4 fino ad A1
- ES**
- Construcción elegante tipo sándwich
  - 2 láminas de acrílico transparente de 3 mm
  - Tamaños de póster desde DIN A4 hasta A1
- FR**
- Élégante construction en sandwich
  - 2 feuilles d'acrylique transparent de 3 mm
  - Taille de poster A4 à A1



Art. nr.	DIN/Size	Dimensions (cm)			
		W	H	D	KG
FS25A4SET	A4	29	37,7	2,9	1,1
FS25A3SET	A3	37,7	50	2,9	1,8
FS25A2SET	A2	50	67,4	2,9	3,2
FS25A1SET	A1	67,4	92,1	2,9	5,5



## WAYFINDING SYSTEM CURVED

- IT**
- Di facile utilizzo
  - Facile da installare
  - Disponibile un'ampia gamma di formati
- ES**
- Uso fácil
  - Instalación fácil
  - Disponible en amplia gama de tamaños
- FR**
- Facile à utiliser
  - Installation aisée
  - Large gamme de tailles disponible



Art. nr.	DIN/Size	Dimensions (cm)			
		W	H	D	KG
ISA6	A6	15,3	10,9	1,6	0,1
IS105x120	10,5 x 12	10,9	12,5	1,6	0,1
IS105x210	10,5 x 21	10,9	21,5	1,6	0,2
IS105x300	10,5 x 30	10,9	30,5	1,6	0,2
ISA5	A5	21,5	15,2	1,8	0,3
ISA4	A4	30,2	21,4	2,2	0,6



## WAYFINDING SYSTEM SNAP

- IT**
- Facile da installare
  - Copertura antiriflesso
  - Cambio rapido delle grafiche
- ES**
- Fácil instalación
  - Folio protector antirreflejos
  - Cambio de gráfica rápido
- FR**
- Installation facile
  - Feuille antireflet
  - Changement rapide des visuels



Art. nr.	DIN/Size	Dimensions (cm)			
		W	H	D	KG
SS155x155	15,5 x 15,5	15,9	16,5	1,3	0,2
SSA6	A6	10,9	15,8	1,3	0,1
SSA5	A5	15,2	22	1,3	0,2
SSA4	A4	21,4	30,7	1,3	0,7





**WALL SIGN CLICK**

- IT**
  - Installazione facile sulla parete con nastro adesivo
  - Pannello con materiale standard BOND da 3 mm
  - Cartello da parete bifacciale per uso interno ed esterno coperto
- ES**
  - Fácil instalación en la pared con cinta adhesiva
  - Material estándar de tablero BOND de 3 mm
  - Señalización de pared de doble cara para interiores y exteriores cubiertos
- FR**
  - Installation facile sur mur avec bande adhésive
  - Matériau standard en panneau BOND de 3 mm
  - Signalétique murale double face pour une utilisation en intérieur et en extérieur couvert



Art. nr.	DIN/Size	Dimensions (cm)			KG
		W	H	D	
WSC100	-	2,5	10,7	2,5	0,1
+ FB100x100WSC-BW3	□ 10 x 10	11,9	10	0,3	0,04
+ FB200x100WSC-BW3	□ 20 x 10	21,9	10	0,3	0,08
+ FB170R100WSC-BW3	○ 17 x 17	19,5	17	0,3	0,2
WSC148	-	2,5	15,5	2,5	0,1
+ FB148x148WSC-BW3	□ 14,8 x 14,8			0,3	0,09
WSC210	-	2,5	21,7	2,5	0,2
+ FB210x210WSC-BW3	□ 21 x 21	22,9	21	0,3	0,2
+ FB400x210WSC-BW3	□ 40 x 21	41,9	21	0,3	0,3
+ FB350R210WSC-BW3	○ 35 x 35	37,5	35	0,3	0,4
WSC300	-	2,5	30,7	2,5	0,2
+ FB300x300WSC-BW3	□ 30 x 30	31,9	30	0,3	0,3
+ FB400x300WSC-BW3	□ 40 x 30	41,9	30	0,3	0,5



• Panels printed in-house by our UV-flatbed printer



**TOTEM PANEL+**

- IT**
  - Design elegante e raffinato con cornice da 25 mm
  - Sostituzione del pannello semplice e veloce dalla parte superiore
  - Bifacciale
- ES**
  - Diseño elegante y moderno con marco de 25 mm
  - Cambio rápido y fácil de panel por la parte superior
  - Doble cara
- FR**
  - Design élégant et épuré avec cadre de 25 mm
  - Changement rapide et facile du panneau par le haut
  - Double face



Art. nr.	DIN/Size	Dimensions (cm)			KG	
		W	H	D		
TPP420x1200	○	45,2	121	32	5	
TPP420x1200BL	●	45,2	121	32	5	
+ FB420x1200GD-FP3	○	42 x 120	42	120	0,3	0,8
TPP2xA1	○		62,6	169,2	40	8,2
TPP2xA1BL	●		62,6	169,2	40	8,2
+ FB594x1682GD-FP3	○	2 x A1	59,4	168,2	0,3	1,5
TPP2x70x100	○		73,2	201	40	9,3
TPP2x70x100BL	●		73,2	201	40	9,3
+ FB700x2000GD-FP3	○	70 x 200	70	200	0,3	2,1

• Panels printed in-house by our UV-flatbed printer



**INDOOR WALL SIGN ECONOMY**

- IT**
  - Soluzione economica per le esigenze di segnaletica murale per interni
  - Fornito con nastro Duplocol per una facile installazione
  - Perfetto per decorazioni murali o segnali informativi
- ES**
  - Solución económica para las necesidades de señalización en paredes interiores
  - Se suministra con cinta Duplocol para una fácil instalación
  - Perfecto para decoración de paredes o carteles informativo
- FR**
  - Une solution économique pour les besoins de signalisation murale intérieure
  - Fourni avec du ruban adhésif Duplocol pour une installation facile
  - Parfait pour la décoration murale ou les panneaux d'information



Art. nr.	DIN/Size	Dimensions (cm)				KG
		W	H	D		
FBE150x150-HW1	15 x 15	15	15	0,2	0,1	
FBE100x300-HW1	10 x 30	10	30	0,2	0,1	
FBE300x400-HW1	30 x 40	30	40	0,2	0,2	

• Panels printed in-house by our UV-flatbed printer



**INDOOR WALL SIGN COMPASSO®**

- IT**
  - Elegante targa da parete
  - Sottile ed elegante cornice di 6 mm di larghezza
  - Adatta per uso interno
- ES**
  - Señalización de pared con estilo
  - Marco fino y elegante de 6 mm de ancho
  - Adecuado para uso en interiores
- FR**
  - Enseigne murale élégante
  - Cadre fin et élégant de 6 mm de large
  - Adapté à une utilisation en intérieur



Art. nr.	DIN/Size	Dimensions (cm)				KG
		W	H	D		
FBCOM400x600-FP3	40 x 60	40,4	60,4	1,5	1,7	
FBCOM500x700-FP3	50 x 70	50,4	70,4	1,5	2,2	
FBCOM600x800-FP3	60 x 80	60,4	80,4	1,5	2,6	
FBCOM700x1000-FP3	70 x 100	70,4	100,4	1,5	3,3	
FBCOM1000x1400-FP3	100 x 140	100,4	140,4	1,5	5,6	

• Panels printed in-house by our UV-flatbed printer

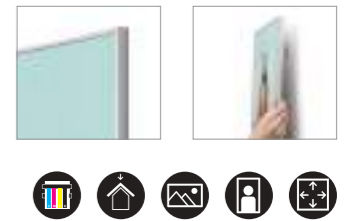

**INDOOR WALL SIGN WITH BRACKET**

- IT**
  - Presentazione elegante alla parete
  - Pannelli sandwich BOND premium
  - Facile da appendere alla parete con staffe a muro e fori già predisposti
- ES**
  - Presentación de pared elegante
  - Paneles BOND tipo sándwich premium
  - Fácil de colgar en la pared con soportes de pared y agujeros prefabricados
- FR**
  - Présentation murale élégante
  - Panneaux sandwichs BOND de qualité supérieure
  - Accrochage mural facile grâce aux fixations murales et aux trous pré-perçés



Art. nr.	DIN/Size	Dimensions (cm)				KG
		W	H	D		
FBFS25-200x200-BW3	20 x 20	20	20	3,2	0,2	
FBFS25-300x400-BW3	30 x 40	30	40	3,2	0,5	
FBFS25-400x600-BW3	40 x 60	40	60	3,2	0,9	

• Panels printed in-house by our UV-flatbed printer



**OVERHEAD BANNERS**

- IT**
  - Banner sospesi
  - Scegli monofacciale o bifacciale
  - Kit di sospensione incluso
- ES**
  - Banners suspendidos en el espacio
  - Puede elegir una o dos caras
  - Kit para colgar incluido
- FR**
  - Bannières suspendues
  - Choisissez le recto ou le recto verso
  - Kit de suspension inclus



Art. nr.	DIN/Size	Dimensions (cm)				KG
		W	H	D		
FBH500x700-KP5	50 x 70	50	70	0,5	0,4	
FBH700x1000-KP5	70 x 100	70	100	0,5	0,7	
FBH600x1200-KP5	60 x 120	60	120	0,5	0,7	
FBH1000x1400-KP5	100 x 140	100	140	0,5	1,3	
FBH500x1000-KP5	50 x 100	50	100	0,5	0,5	

Double-sided						
Art. nr.	DIN/Size	Dimensions (cm)				KG
		W	H	D		
FBH500x700D-KP5	50 x 70	50	70	0,5	0,4	
FBH700x1000D-KP5	70 x 100	70	100	0,5	0,7	
FBH600x1200D-KP5	60 x 120	60	120	0,5	0,7	
FBH1000x1400D-KP5	100 x 140	100	140	0,5	1,3	
FBH500x1000D-KP5	50 x 100	50	100	0,5	0,5	

• Panels printed in-house by our UV-flatbed printer





## INDOOR WALL SIGN BASIC

- IT**
- Adatto a qualsiasi superficie di parete interna
  - Disponibile in molte dimensioni e diversi materiali
  - Scegli il materiale del pannello FOREX® o KAPA®
- ES**
- Adecuado para cualquier superficie de pared interior
  - Disponible en muchos tamaños y varios materiales
  - Elija tableros FOREX® o KAPA®
- FR**
- Convient à toute surface murale intérieure
  - Disponibles dans de nombreuses tailles et dans différents matériaux
  - Choisissez les panneaux FOREX® ou KAPA®

Art. nr.	DIN/Size	Dimensions (cm)				KG
		W	H	D		
<b>Forex® Boards</b>						
FBW300x400-FP3	30 x 40	30	40	0,3	0,2	
FBW400x600-FP3	40 x 60	40	60	0,3	0,4	
FBW500x700-FP3	50 x 70	50	70	0,3	0,5	
FBW600x800-FP3	60 x 80	60	80	0,3	0,7	
FBW700x1000-FP3	70 x 100	70	100	0,3	1,0	
FBW600x1200-FP3	60 x 120	60	120	0,3	1,0	
FBW1000x1400-FP3	100 x 140	100	140	0,3	2,0	
FBW500x1000-FP3	50 x 100	50	100	0,3	0,7	
<b>Kapa® Boards</b>						
FBW300x400-KP5	30 x 40	30	40	0,5	0,1	
FBW400x600-KP5	40 x 60	40	60	0,5	0,2	
FBW500x700-KP5	50 x 70	50	70	0,5	0,3	
FBW600x800-KP5	60 x 80	60	80	0,5	0,4	
FBW700x1000-KP5	70 x 100	70	100	0,5	0,6	
FBW600x1200-KP5	60 x 120	60	120	0,5	0,6	
FBW1000x1400-KP5	100 x 140	100	140	0,5	1,2	
FBW500x1000-KP5	50 x 100	50	100	0,5	0,4	

• Panels printed in-house by our UV-flatbed printer



## OUTDOOR WALL SIGN

- IT**
- Materiale BOND premium per uso esterno
  - Molte dimensioni disponibili
  - Classificazione ignifuga B1
- ES**
- Material BOND premium para uso en exteriores
  - Muchos tamaños disponibles
  - Certificación ignífuga B1
- FR**
- Matériau BOND de qualité supérieure pour une utilisation en extérieur
  - De nombreuses tailles disponibles
  - Protection de classe B1 contre le feu



Art. nr.	DIN/Size	Dimensions (cm)			
		W	H	D	KG
FBO500x500-BW3	50 x 50	50	50	0,3	0,9
FBO1000x1000-BW3	100 x 100	100	100	0,3	3,6
FBO500x700-BW3	50 x 70	50	70	0,3	1,3
FBO600x800-BW3	60 x 80	60	80	0,3	1,7
FBO700x1000-BW3	70 x 100	70	100	0,3	2,5
FBO1000x1400-BW3	100 x 140	100	140	0,3	5,0

• Panels printed in-house by our UV-flatbed printer



Overhead Banners (p. 185/ch. 12)



### BARRIER FLEXI BELT POST

- IT**
- Nastro estensibile da 2,7 m
  - Piastra di base pesante con una buona stabilità
  - Ideale per gestire le code
- ES**
- Cinta tensada retráctil de 2,7 metros
  - Sólida base para buena estabilidad
  - Ideal para guiado de filas
- FR**
- Courroie tendue rétractable de 2,7 m
  - Lourde plaque de base avec bonne stabilité
  - Idéale pour le guidage de file d'attente



Art. nr.	Pole		Dimensions (cm)			
	W	H	D	KG		
BBBLACK	●	●	36	105	36	12,3
BBCHROME	○	●	36	105	36	12,3

Optional: Barrier Sign Holder (see p. 191)

### BARRIER FLEXI BELT POST ECONOMY

- IT**
- Montante autoportante con aggancio nastro su 3 lati e nastro da 2,5 m
  - Ideale per gestire le code
  - Ottimo rapporto qualità-prezzo
- ES**
- Poste separador con clips de recepción en 3 lados y cinta tensada de 2,5 metros
  - Ideal para guiado de filas
  - Buena relación calidad-precio
- FR**
- Pied indépendant avec clip de ceinture à 3 côtés et tapis de 2,5 m
  - Idéal pour le guidage de file d'attente
  - Excellent rapport qualité-prix



Art. nr.	Dimensions (cm)				
	W	H	D	KG	
BBEBLACK	●	30	93,5	30	8,6
BBECHROME	○	30	93,5	30	8,6

Optional: Barrier Sign Holder (see p. 191)

### BARRIER FLEXI BELT WALL MOUNTED

- IT**
- Sistema di guida fissato al muro
  - Nastro estensibile da 3 m
  - 3 possibilità di aggancio per nastri flessibili
- ES**
- Sistema de guiado de pared
  - Cinta flexible de 3 metros
  - 3 posibilidades de clip para la cinta flexible
- FR**
- Système de guidage mural
  - Courroie flexible de 3 m
  - Possibilité de 3 clips pour courroies flexibles



Art. nr.	Dimensions (cm)				
	W	H	D	KG	
BSBWBLACK	●	8	12	7,5	0,7

### BARRIER GOLD ROPE STAND

- IT**
- Design antico
  - Colonnina in alluminio con solida base in acciaio
  - Peso totale di 9 kg per un'eccellente stabilità
- ES**
- Diseño antiguo
  - Poste de aluminio con base sólida de acero
  - Peso total de 9 kg para óptima estabilidad
- FR**
- Design antique
  - Poteau en aluminium avec base en acier lourd
  - Poids total de 9 kg pour une stabilité optimale



Art. nr.	Dimensions (cm)				
	W	H	D	KG	
BSRGOLD	●	31	94	31	9,9

Optional: Barrier Gold Rope and Barrier Gold Wall Hook (see p. 191)

### BARRIER CHROME ROPE STAND

- IT**
- Design antico
  - Colonnina in alluminio con solida base in acciaio
  - Peso totale di 9 kg per un'eccellente stabilità
- ES**
- Diseño antiguo
  - Poste de aluminio con base sólida de acero
  - Peso total de 9 kg para óptima estabilidad
- FR**
- Design antique
  - Poteau en aluminium avec base en acier lourd
  - Poids total de 9 kg pour une stabilité optimale



Art. nr.	Dimensions (cm)				
	W	H	D	KG	
BSRCHROME	○	31	98,7	31	9,9

Optional: Barrier Chrome Rope and Barrier Chrome Wall Hook (see p. 191)

FENCE BARRIER GRAPHIC

NEW

- IT**
  - Pubblicità esterna conveniente
  - Progettato per adattarsi alla parte superiore delle barriere di recinzione standard
  - Grafica bifacciale con altezza di 80 cm
- ES**
  - Publicidad exterior asequible
  - Diseñado para adaptarse a la parte superior de barreras estándar
  - Impresión doble cara con una altura de 80 cm
- FR**
  - Solution abordable pour la publicité extérieure
  - Conçu pour s'adapter à la partie supérieure des barrières standard
  - Impression recto-verso avec une hauteur de 80 cm



Art. nr.	DIN/Size	Dimensions (cm)			
		W	H	D	KG
MFB200-80GDS	190 x 80	190	80	0,3	0,9
MFB250-80GDS	240 x 80	240	80	0,3	1,1

Hardware must be sourced externally

ZIPPER-BARRIER

- IT**
  - Transenna segnapercorso interna per mostre, centri commerciali, luoghi pubblici e molto altro
  - Sistema leggero con base solida e stabile
  - Perfetta per opportunità promozionali eccezionali
- ES**
  - Postes separadores con cinta para ferias, centros comerciales, espacios públicos y mucho más
  - Un sistema ligero con una base estable y pesada
  - Perfecto para grandes oportunidades de publicidad
- FR**
  - Barrière anti-foule intérieure pour les expositions, les centres commerciaux, les espaces publics, etc.
  - Un système léger avec une base stable et solide
  - Idéal pour de grandes actions publicitaires



Art. nr.	Dimensions (cm)			
	W	H	D	KG
ZWBARRIER	206	107	36,2	4,8

Tip! Connect multiple Zipper-Barrier easily together thanks to special designed feet  
Included luxurious soft carry bag

BARRIER SIGN HOLDER

Accessory for Barrier Flexi Belt Post



- IT**
  - Espositore bifacciale A4 per attirare l'attenzione sulla transenna
- ES**
  - Tarjeta superior A4 de doble cara para llamar la atención
- FR**
  - Carte supérieure double face A4 pour attirer l'attention sur la barrière

Art. nr. BBBLACKSIGNA4 ●

BARRIER SIGN HOLDER

Accessory for Barrier Flexi Belt Post Economy



- IT**
  - Espositore bifacciale A4 per attirare l'attenzione sulla transenna
- ES**
  - Tarjeta superior A4 de doble cara para llamar la atención
- FR**
  - Carte supérieure double face A4 pour attirer l'attention sur la barrière

Art. nr. BBBLACKSIGNA4 ●  
BBECHROMESIGNA4 ●

BARRIER GOLD ROPE

Accessory for Barrier Gold Rope Stand



- IT**
  - Cordone di velluto intrecciato o spazzolato premium
- ES**
  - Cuerda trenzada o de terciopelo de altísima calidad
- FR**
  - Corde de velours torsadée ou brossée de qualité supérieure

Art. nr. Twisted rope BSRRPGLDBLACK ●  
Brush velour rope BSRRPGLDRED ●

BARRIER CHROME ROPE

Accessory for Barrier Chrome Rope Stand



- IT**
  - Cordone di velluto intrecciato o spazzolato premium
- ES**
  - Cuerda trenzada o de terciopelo de altísima calidad
- FR**
  - Corde de velours torsadée ou brossée de qualité supérieure

Art. nr. Twisted rope BSRRPCHRBLACK ●  
Brush velour rope BSRRPCHRBLUE ●  
BSRRPCHRRED ●

## 13. GLASS SHOWCASES

Bacheche di vetro  
Vitrinas en vidrio  
Vitrines en verre

Elegantly designed glass showcases are effective for putting valuables and collectables on display. Ideal for museums, offices, waiting rooms, retail stores and trade shows. Built from anodised aluminium profiles and glass elements. Available with lockable single and double glass doors as well as LED lighting options.

### INDEX

13.1 Glass Showcases **194**  
*Glasvitrinen*  
*Glazen Vitrines*

- ✦ **TEMPERED GLASS FOR STABILITY**
- ✦ **SILVER AND BLACK FINISH, WIDE RANGE OF SIZES**
- ✦ **LED ILLUMINATED OPTIONS TO HIGHLIGHT EXPOSED ITEMS**

### GLASS SHOWCASE 800 MM / 800 MM DOUBLE DOOR

- IT**
  - Struttura in alluminio con vetro temperato
  - 4 ripiani in vetro regolabili che possono sopportare fino a 10 kg
  - Anta doppia con serrature a cilindro
- ES**
  - Construcción de aluminio con cristal reforzado
  - 4 estantes de cristal que llegan a soportar hasta 10 kg
  - Doble puerta con bisagras y cerraduras cilíndricas
- FR**
  - Structure en aluminium avec verre trempé
  - 4 clayettes en verre réglables pouvant contenir jusqu'à 10 kg
  - Porte à charnières avec serrures à barillet



Art. nr.	Dimensions (cm)			
	W	H	D	KG
VR2-24-800	80	200	40	78,7
VR2-24-800F	80	200	40	79,2

Black colour available on request

### GLASS SHOWCASE ILLUMINATED 400 MM

- IT**
  - Struttura in alluminio con vetro temperato
  - Lampade LED in cima alla vetrina in vetro
  - Anta battente con serrature a cilindro
- ES**
  - Construcción de aluminio con cristal reforzado
  - Lámparas LED en la parte superior de la vitrina
  - Puerta con bisagras y cerraduras cilíndricas
- FR**
  - Construction en aluminium avec verre trempé
  - Lampes à LED sur le dessus de la vitrine en verre
  - Porte à charnières avec serrures à barillet



Art. nr.	Dimensions (cm)			
	W	H	D	KG
VR2-24-400LED	40	200	40	53,5

Black colour available on request

### GLASS SHOWCASE ILLUMINATED 800 MM / 800 MM DOUBLE DOOR

- IT**
  - Struttura in alluminio con vetro temperato
  - Lampade LED in cima alla vetrina in vetro
  - Anta doppia con serrature a cilindro
- ES**
  - Construcción de aluminio con cristal reforzado
  - Lámparas LED en la parte superior de la vitrina
  - Doble puerta con bisagras y cerraduras cilíndricas
- FR**
  - Construction en aluminium avec verre trempé
  - Lampes à LED sur le dessus de la vitrine en verre
  - Double porte avec serrures à barillet

Art. nr.	Dimensions (cm)			
	W	H	D	KG
VR2-24-800FLED	80	200	40	73

Black colour available on request



## 14. BROCHURE HOLDERS

### Porta documenti Portafolletos Porte-brochures

Brochure Holders are designed to keep promotional materials and literature well organised and visible to the public. A wide range of designs and sizes for catalogues, leaflets, magazines, business cards and other literature.

- ALL POPULAR SIZES POSSIBLE, FROM BUSINESS CARDS TO CATALOGUES
- EASY TO USE AND TRANSPORT
- SILVER, BLACK OR WHITE FINISHES TO FIT EVERY ENVIROMENT

### INDEX

- |   |            |
|---|------------|
| 14.1 Scritto® Brochure Holders<br><i>Porta documenti Scritto®<br/>Scritto® Portafolletos<br/>Scritto® Porte-brochures</i>   | <b>198</b> |
| 14.2 Taymar® Brochure Holders<br><i>Porta documenti Taymar®<br/>Taymar® Portafolletos<br/>Taymar® Porte-brochures</i>   | <b>199</b> |
| 14.3 Business Card Holders<br><i>Porta biglietti da visita<br/>Portafolletos Tarjetas de<br/>Visita<br/>Porte-Cartes de Visite</i>  | <b>201</b> |
| 14.4 Outdoor Leaflet Holders<br><i>Porta biglietti da visita per<br/>uso esterno<br/>Portafolletos para Exteriores<br/>Porte-brochures pour<br/>Extérieur</i>   | <b>202</b> |
| 14.5 Name Badges and Brochure Holder Magnetic<br><i>Portanomi e portadocumenti<br/>magnetici<br/>Porta Nombres y<br/>Portafolletos Magnético<br/>Badges Nominatifs et<br/>Portebrochures<br/>Magnétique</i> | <b>203</b> |



#STAYHOME

Improve  
Face  
Recognition

## 14.1 SCRITTO® BROCHURE HOLDERS

### DA4P

**BESTSELLER**



- IT • Ripiano e fissaggio al muro
- ES • Posibilidad de poner en mostrador o en pared
- FR • Montage sur comptoir et mural

Art. nr.	Pocket depth (cm)	DIN/Size	Dimensions (cm)		
			W	H	D
DA4P	6,4	1 x A4	22,4	26,6	9,4

### 3DA4P



- IT • Ripiano e fissaggio al muro
- ES • Posibilidad de poner en mostrador o en pared
- FR • Montage sur comptoir et mural

Art. nr.	Pocket depth (cm)	DIN/Size	Dimensions (cm)		
			W	H	D
3DA4P	3,1	3 x A4	22,4	25,9	12,1
4DA4P	3	4 x A4	22,4	29,9	19

### 4DA4P

**BESTSELLER**



## 14.2 TAYMAR® BROCHURE HOLDERS

### W230X



- IT • Fissaggio al muro (W230X), ripiano e fissaggio al muro (W230, C330)
- ES • Montaje en la pared (W230X), posibilidad de poner en mostrador o en pared (W230, C330)
- FR • Montage mural (W230X), montage sur comptoir et mural (W230, C330)

Art. nr.	Pocket depth (cm)	DIN/Size	Dimensions (cm)		
			W	H	D
W230X	3,2	1 x A4	24	25	4
W230	3,2	1 x A4	24	25	4

### W230



### C330



Art. nr.	Pocket depth (cm)	DIN/Size	Dimensions (cm)		
			W	H	D
C330	3,2	1 x A4	34	18,6	7,8

### DA5P

**BESTSELLER**



- IT • Ripiano e fissaggio al muro
- ES • Posibilidad de poner en mostrador o en pared
- FR • Montage sur comptoir et mural

Art. nr.	Pocket depth (cm)	DIN/Size	Dimensions (cm)		
			W	H	D
DA5P	5,3	1 x A5	15,7	20,8	7,4
4DA5P	2,5	4 x A5	15,7	25,5	15,8

### 4DA5P

**BESTSELLER**



### D13A4P

**BESTSELLER**



- IT • Ripiano e fissaggio al muro
- ES • Posibilidad de poner en mostrador o en pared
- FR • Montage sur comptoir et mural

Art. nr.	Pocket depth (cm)	DIN/Size	Dimensions (cm)		
			W	H	D
D13A4P	4,8	1 x 1/3 A4	10,8	20,9	6,5
4D13A4P	2,5	4 x 1/3 A4	10,8	25,5	15,8

### 4D13A4P

**BESTSELLER**



### C230

**BESTSELLER**



- IT • Ripiano (C230), ripiano e fissaggio al muro (2C230X), Fissaggio al muro (3W230)
- ES • Para mostrador (C230), posibilidad de poner en mostrador o en pared (2C230X), montaje en la pared (3W230)
- NL • Comptoir (C230), montage sur comptoir et mural (2C230X), montage mural (3W230)

Art. nr.	Pocket depth (cm)	DIN/Size	Dimensions (cm)		
			W	H	D
C230	3,2	1 x A4	23,3	24,9	8,5
2C230X	3,2	2 x A4	23,7	28,5	12,4

### 2C230X



### 3W230



Art. nr.	Pocket depth (cm)	DIN/Size	Dimensions (cm)		
			W	H	D
3W230	3,2	3 x A4	23,7	53,5	10,2

### PWA4P



- IT • Fissaggio al muro
- ES • Montaje en la pared
- FR • Montage mural

Art. nr.	DIN/Size	Dimensions (cm)		
		W	H	D
PWA4P	A4	27	25,5	9,4

### 3C230



- IT • Ripiano (3C230), ripiano e fissaggio al muro (4C230X)
- ES • Para mostrador (3C230), posibilidad de poner en mostrador o en pared (4C230X)
- FR • Comptoir (3C230), montage sur comptoir et mural (4C230X)

Art. nr.	Pocket depth (cm)	DIN/Size	Dimensions (cm)		
			W	H	D
3C230	3,2	3x A4	23,7	33,9	15,5
4C230X	3,2	4x A4	23,6	34	17,5

### 4C230X

**BESTSELLER**



## 14.2 TAYMAR® BROCHURE HOLDERS

**W160**



**C160**



**BESTSELLER**

**3C160**



**4C160**



**BESTSELLER**

- IT** • Ripiano e fissaggio al muro (W160, 3C160, 4C160), ripiano (C160)  
**ES** • Posibilidad de poner en mostrador o en pared (W160, 3C160, 4C160), posibilidad de poner en mostador (C160)  
**FR** • Montage sur comptoir et mural (W160, 3C160, 4C160), montage sur comptoir (C160)

Art. nr.	Icon	Pocket depth (cm)	DIN/Size	Dimensions (cm)		
				W	H	D
W160	□	3,2	1x A5	16,5	19,1	3,5
C160	□	3,2	1x A5	16,5	21,4	7,5 80

Art. nr.	Icon	Pocket depth (cm)	DIN/Size	Dimensions (cm)		
				W	H	D
3C160	□	3,2	3x A5	16,6	21,8	11
4C160	□	3,2	4x A5	16,6	25,6	15,5

**3C104**



**4C110**



**BESTSELLER**

**C110**



**BESTSELLER**

**W110**



- IT** • Ripiano e fissaggio al muro (3C104, W110), counter top (4C110, C110)  
**ES** • Posibilidad de poner en mostrador o en pared (3C104, W110), posibilidad de poner en mostador (4C110, C110)  
**FR** • Montage sur comptoir et mural (3C104, W110), montage sur comptoir (4C110, C110)

Art. nr.	Icon	Pocket depth (cm)	DIN/Size	Dimensions (cm)		
				W	H	D
3C104	□	3,2	3x 1/3 A4	10,9	21,8	11,2
4C110	□	3,2	4x DL	11,5	25,5	15

Art. nr.	Icon	Pocket depth (cm)	DIN/Size	Dimensions (cm)		
				W	H	D
C110	□	3,2	1x DL	11,4	18,1	6,5
W110	□	3,2	1x DL	11,5	15	4

**4C230**



**4C330**



**WPA6**



- IT** • Ripiano e fissaggio al muro  
**ES** • Posibilidad de poner en mostrador o en pared  
**FR** • Montage sur comptoir et mural

Art. nr.	Icon	Pocket depth (cm)	DIN/Size	Dimensions (cm)		
				W	H	D
4C230	□	3,2	8x DL	23,6	34	17,5
4C330	□	3,2	12x DL	34	34,5	17,5

Art. nr.	Icon	Pocket depth (cm)	DIN/Size	Dimensions (cm)		
				W	H	D
WPA6	□	3,2	1x A6	11,5	12	3,8

## 14.3 BUSINESS CARD HOLDERS

**WBC93**



**VCR92**



**BESTSELLER**

**BC93**



**BESTSELLER**

**4VCS95**



- IT** • Fissaggio al muro (WBC93), Ripiano (VCR92)  
**ES** • Montaje en la pared (WBC93), para mostrador (VCR92)  
**FR** • Montage mural (WBC93), comptoir (VCR92)

Art. nr.	Icon	Pocket depth (cm)	DIN/Size	Dimensions (cm)		
				W	H	D
WBC93	□	1,8	9,3 x 5	10,1	3,7	2,3
VCR92	□	1,8	9,3 x 5	9,6	4,3	2,8

- IT** • Ripiano  
**ES** • Para mostrador  
**FR** • Comptoir

Art. nr.	Icon	Pocket depth (cm)	DIN/Size	Dimensions (cm)		
				W	H	D
4VCS95	□	1,7	4x (9,3 x 5)	9,9	10,1	8,6
BC93	□	1,7	5 x 9,3	19,7	10	9



## 14.4 OUTDOOR LEAFLET HOLDERS

### OD95



- IT** • Resistente alle intemperie (antispruzzo) e polistirolo trasparente  
**ES** • Resistente a la intemperie (a prueba de salpicaduras)  
**FR** y de poliestireno transparente  
 • Résistant aux intempéries (éclaboussures) et polystyrène

Art. nr.	DIN/Size	Dimensions (cm)		
		W	H	D
OD95	1 x 9,3 x 5	10,6	6,2	3,2

### OD110



- IT** • Resistente alle intemperie (antispruzzo) e polistirolo trasparente  
**ES** • Resistente a la intemperie (a prueba de salpicaduras)  
**FR** y de poliestireno transparente  
 • Résistant aux intempéries (éclaboussures) et polystyrène

Art. nr.	DIN/Size	Dimensions (cm)		
		W	H	D
OD110	1x DL	11,3	22,7	3,4

### OD160



- IT** • Resistente alle intemperie (antispruzzo) e polistirolo trasparente  
**ES** • Resistente a la intemperie (a prueba de salpicaduras)  
**FR** y de poliestireno transparente  
 • Résistant aux intempéries (éclaboussures) et polystyrène

Art. nr.	DIN/Size	Dimensions (cm)		
		W	H	D
OD160	1x A5	16,5	22,7	4,4

### OD230



- IT** • Resistente alle intemperie (antispruzzo) e polistirolo trasparente  
**ES** • Resistente a la intemperie (a prueba de salpicaduras)  
**FR** y de poliestireno transparente  
 • Résistant aux intempéries (éclaboussures) et polystyrène

Art. nr.	DIN/Size	Dimensions (cm)		
		W	H	D
OD230	1x A4	24	32	4,8

## 14.5 NAME BADGES AND BROCHURE HOLDER MAGNETIC

### NB65S



- IT** • Design piatto con chiusura e perno di sicurezza  
**ES** • Diseño plano con un clip e imperdible  
**FR** • Conception plate avec clip et goupille de sécurité

Art. nr.	DIN/Size	Dimensions (cm)		
		W	H	D
NB65S	6,5 x 3,1	6,5	3,5	1

### BHMA5



- IT** • Adatto a tutti i Porta Banner Roll Up, Porta Banner e Pareti in tessuto  
**ES** • Adecuado para Roll-Ups, Banners y las paredes textiles  
**FR** • Convient aux Roll-up, aux Banner Stands et murs Textiles

Art. nr.	DIN/Size	Dimensions (cm)		
		W	H	D
BHMA5	A5	16,5	20,5	1,5

# PROMOTIONS AND EVENTS

Promozioni ed eventi  
Promociones y Eventos  
Promotions et événements



All eyes on your brand, promotion or presentation with our promotional displays. Various sizes, graphics, designs and options to be the perfect fit for every product presentation, exhibition or event.



**ZIPPER-WALL STRAIGHT BASIC**  
See 18. Walls  
Page 278



**ZIPPER-WALL CURVED BASIC**  
See 18. Walls  
Page 281

**BEACH FLAG ALU WIND & PADDLE**  
See 16. Flags  
Page 242



**ZIG ZAG BROCHURE STAND FOLDABLE**  
See 6. Leaflet and Catalogue Holders  
Page 111



**DIGITAL COUNTER FUTURO**  
See 17. Counters and Table Covers  
Page 250



**COUNTER IMPRESS**  
See 17. Counters and Table Covers  
Page 256



**POP-UP IMPRESS STRAIGHT**  
See 18. Walls  
Page 272



**ZIPPER-BARRIER**  
See 12. Wayfinding Systems  
Page 190



**ZIPPER-BANNER COBRA**  
See 15. Banners  
Page 226



**DIGITAL A-BOARD SPECTRUM**  
See 4. Digital Displays  
Page 77



**ZIPPER-BANNER SLIM**  
See 15. Banners  
Page 224

**CUBE SEAT CLASSIC**  
See 19. Tents, Umbrellas and Seats  
page 300



**CUBE SEAT FOLD**  
See 19. Tents, Umbrellas and Seats  
page 300

NEW



**BRIGHTBOX PRO FLEX WALL**  
See 18. Walls  
Page 268



**BRIGHTBOX DOUBLE**  
See 3. Illuminated Displays  
Page 56



**COUNTER EASY OVAL**  
See 17. Counters and Table Covers  
Page 259



**TENT ALU**  
See 19. Tents, Umbrellas and Seats  
Page 290

interesting categories for you

3. ILLUMINATED DISPLAYS	48
4. DIGITAL DISPLAYS	62
6. LEAFLET AND CATALOGUE HOLDERS	106
12. WAYFINDING SYSTEMS	178
15. BANNERS	206
16. FLAGS	234
17. COUNTERS AND TABLE COVERS	248
18. WALLS	266
19. TENTS, UMBRELLAS & SEATS	288

# 15. BANNERS

## Porta banners Banners Banners

Banners are the most popular, versatile and widely used mobile displays in the world. Designed for quick, easy and effective promotional use. Perfect for a variety of settings, from trade shows to shopping malls, airports to restaurants. Available for indoor and outdoor use, in a wide range of styles and sizes to meet any budget. Packaged in a convenient travel case.

- QUICK AND EASY CHANGE OF GRAPHICS
- GRAPHIC AVAILABLE TO CUSTOMISE YOUR BANNER
- DURABLE AND ELEGANT

### INDEX

- 15.1 Roll-Banners **208**  
Roll-Banners  
Roll-Banners  
Roll-Banners
- 15.2 Bannerstands **218**  
Porta banners  
Banner  
Supports pour Bannières
- 15.3 Hanging Banners **230**  
Porta banners a  
sospensione  
Banners Colgantes  
Banners Suspendues
- 15.4 Accessories **232**  
Accessori  
Accesorios  
Accessoires



### ✓ GOOD ROLL-BANNER BASIC

- Extremely reliable
- Height adjustable with optional extension pole
- Affordable banner for promotional or project use

### 👍 BETTER ROLL-BANNER DELUXE

- Extremely durable banner with an elegant finish
- Roll-Banner with easy graphic exchange
- Height adjustable

### 🏆 BEST ZIPPER-BANNER SLIM

- Great alternative for the standard Roll-Banner
- Single-sided or double-sided wrinkle-free fabric cover
- Easy-to-assemble click system

SELECTION TABLE

	Colour	Page	Side view	Width	Height	KG	Single-sided (S) or double-sided (D) print	Number of poles	Telescopic pole	Height indication on pole	Adhesive on bottom	Snap profile on bottom	Number of feet	Foot type	Top profile type	Bag type	
Budget	○	204		80	200	1,8	S	1			x		2	F3	P2	B1	
				85	200	1,9		1		x				2	F3	P2	B1
				100	200	2,1		1		x				2	F3	P2	B1
Challenger Alu	○	205		80	200	2	S	1			x		2	F2	P1	B3	
				85	200	2,1		1		x				2	F2	P1	B3
				100	200	2,3		1		x				2	F2	P1	B3
Challenger Next	○●	205		85	200	2,1	S	1			x		2	F3	P1	B3	
				100	200	2,3		1		x				2	F3	P1	B3
Challenger Black	●	205		85	200	2,1	S	1			x		2	F2	P1	B3	
				100	200	2,3		1		x				2	F2	P1	B3
Basic 1 foot	○	205		60	200	2,3	S	1			x		1	F2	P2	B4	
Basic 2 feet	○	205		80	200	2,8	S	1			x		2	F2	P2	B4	
				85	200	2,8		1		x				2	F2	P2	B4
				100	200	3,2		1		x				2	F2	P2	B4
				120	200	3,9		2		x				2	F2	P2	B4
				150	200	4		2		x				2	F2	P2	B4
Basic Black	●	205		85	200	2,8	S	1			x		2	F2	P2	B4	
				100	200	3,2		1		x				2	F2	P2	B4
Plus	○	206		60	200	2,2	S	1			x		2	F3	P2	B3	
				80	200	2,2		1		x				2	F3	P2	B3
				85	200	2,8		1		x				2	F3	P2	B3
				100	200	3,2		1		x				2	F3	P2	B3
				120	200	4,1		2		x				2	F3	P2	B3
				150	200	4,8		2		x				2	F3	P2	B3
Triangle	○	206		85	160-220	3,5	S	1	x		x		1	F4	P2	B4	
				100	160-220	3,8		1	x		x			1	F4	P2	B4
				150	160-220	6,1		2	x		x			2	F4	P2	B4
Evolution	○	207		85	160-220	3,6	S	1	x		x		1	F5	P3	B4	
				100	160-220	4,1		1	x		x			1	F5	P3	B4
				120	160-220	4,9		1	x		x			2	F5	P3	B4
				150	160-220	6		2	x		x			2	F5	P3	B4
Premium	○	208		85	160-220	5,7	S	1	x		x		0		P3	B5	
				100	160-220	6,8		1	x		x			0		P3	B5
				120	160-220	8,3		1	x		x			0		P3	B5
				150	160-220	10		2	x		x			0		P3	B5
Premium Black	●	208		85	160-220	5,7	S	1	x		x		0		P3	B5	
				100	160-220	6,8		1	x		x			0		P3	B5
Massive	○	208		85	160-220	4,1	S	1	x		x		1	F6	P3	B4	
				100	160-220	5		1	x		x			1	F6	P3	B4
Premium Clamp	○	209		85	160 - 225	5,5	S	1	x		x		0		P3	B5	
				100	160 - 225	5,7		1	x		x			0		P3	B5
Deluxe	○	209		85	160 - 225	5,3	S	1	x	x			0		P3	B5	
				100	160 - 225	6		1	x	x				0		P3	B5
Twin	○	210		85	200	4,6	D	1			x	x	0		P1	B5	
				100	200	5,2		1			x	x		0		P1	B5
Double	○	210		85	200	6,6	D	1			x		0		P3	B5	
				100	200	7,6		1			x			0		P3	B5
Extreme	○	211		150	170-270	9,8	S	2	x	x	x		2	F4	P4	B4	
				200	170-300	11,6		2	x	x	x			2	F4	P4	B4

Foot type F2



Foot type F3



Foot type F4



Foot type F5



Foot type F6



Top profile type P1



Top profile type P2



Top profile type P3



Top profile type P4



Bag type B1



Bag type B2



Bag type B3



Bag type B4



Bag type B5



More information about the printing options, see page 302 & 303

**ROLL-BANNER BUDGET**

- IT**
  - Cassetta leggera
  - Ottimo rapporto qualità-prezzo
  - Adatto per un uso promozionale o di progetto
- ES**
  - Base ligera
  - Excelente relación calidad-precio
  - Adecuado para uso promocional o de proyectos
- FR**
  - Cassette légère
  - Excellent rapport qualité/prix
  - Adapté à un usage promotionnel ou à un projet



**BESTSELLER**



Art. nr.	Dimensions (cm)		
	W	H	KG
RBB080	80	200	1,8
RBB085	85	200	1,9
RBB100	100	200	2,1

**ROLL-BANNER CHALLENGER**

- IT**
  - Aspetto leggero ed elegante
  - Disponibile in 3 colori
  - Ideale per i più svariati eventi indoor
- ES**
  - Aspecto ligero y elegante
  - Disponible en 3 variaciones de color
  - Ideal para los eventos de interior más diversos
- NL**
  - Look léger et élégant
  - Disponible en 3 coloris
  - Idéal pour la plupart des événements en intérieur



Art. nr.		Dimensions (cm)		
		W	H	KG
<b>Alu</b>				
RBCHA080	○	80	200	2
RBCHA085	○	85	200	2,1
RBCHA100	○	100	200	2,3
<b>Next</b>				
RBCHN085	○●	85	200	2,1
RBCHN100	○●	100	200	2,3
<b>Black</b>				
RBCHB085	●	85	200	2,1
RBCHB100	●	100	200	2,3

**ROLL-BANNER BASIC**

- IT**
  - Estremamente affidabile
  - Altezza regolabile con palo di prolunga opzionale
  - Banner accessibile per un uso promozionale o di progetto
- ES**
  - Extremadamente confiable
  - Altura ajustable con poste de extensión opcional
  - Banner económico para uso promocional o de proyectos
- FR**
  - Extrêmement fiable
  - Hauteur réglable avec un mât optionnel
  - Bannière abordable pour une utilisation promotionnelle ou basée sur un projet



Art. nr.		Feet	Dimensions (cm)		
			W	H	KG
RBBAS1F060	○	1	60	200	2,3
RBBAS2F080	○	2	80	200	2,8
RBBAS2F085	○	2	85	200	2,8
RBBAS2F100	○	2	100	200	3,2
RBBAS2F120	○	2	120	200	3,9
RBBAS2F150	○	2	150	200	4
RBBASB085	●	2	85	200	2,8
RBBASB100	●	2	100	200	3,2

➤ **Optional: Lengthening Pole (+ 20 cm height) in silver and black see p. 232**

➤ **Available in 3 types of graphic materials (see p. 302 - 303)**

➤ **See accessories page for options (p. 234)**



**ROLL-BANNER PLUS**

- IT**
  - Solido, elegante e affidabile
  - I tappini neri sui piedini evitano danni alla superficie
  - Cassetta solida e pesante
- ES**
  - Robusto, fiable y elegante
  - Casquillos negros en los pies de evitar daños a la superficie
  - Base sólida y resistente
- FR**
  - Stable, élégant et fiable
  - Les embouts noirs sur les pieds empêchent d'endommager la surface
  - Lourde cassette solide



Art. nr.	Dimensions (cm)		
	W	H	KG
RBPL060	60	200	2,2
RBPL080	80	200	2,2
RBPL085	85	200	2,8
RBPL100	100	200	3,2
RBPL120	120	200	4,1
RBPL150	150	200	4,8

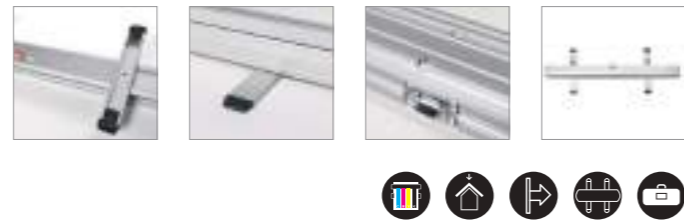

**ROLL-BANNER EVOLUTION**

- IT**
  - Aspetto elegante e alla moda
  - Altezza regolabile
  - Vano aggiuntivo per alloggiamento del palo nella custodia
- ES**
  - Aspecto elegante y con estilo
  - Altura ajustable
  - Compartimiento de almacenamiento adicional para la bolsa
- FR**
  - Un look élégant et stylé
  - Réglable en hauteur
  - Sac avec rangement supplémentaire pour le mât



Art. nr.	Feet	Dimensions (cm)		
		W	H	KG
RBEVO085	1	85	160-220	3,6
RBEVO100	1	100	160-220	4,1
RBEVO120	2	120	160-220	4,9
RBEVO150	2	150	160-220	6



Roll-Banner Open-Air (p. 217/ch. 15) and Window Snap Frame (p. 23/ch. 1)

**ROLL-BANNER TRIANGLE**

- IT**
  - Forma che risalta e stabilità eccellente
  - Piedino estraibile con cuscinetti antiscivolo e clip di chiusura
  - Altezza regolabile
- ES**
  - Soporte a la última y con una excelente estabilidad
  - Pies con almohadillas antideslizantes y clip de fijación
  - Altura ajustable
- FR**
  - Forme remarquable et excellente stabilité
  - Pied pivotant avec coussinets antidérapants et clip de blocage
  - Réglable en hauteur



Art. nr.	Feet	Dimensions (cm)		
		W	H	KG
RBTR085	1	85	160-220	3,5
RBTR100	1	100	160-220	3,8



### ROLL-BANNER PREMIUM

- IT**
  - Cassetta elegante con tappi laterali cromati
  - Aspetto esclusivo
  - Altezza regolabile
- ES**
  - Base elegante con tapas laterales cromadas
  - Apariencia exclusiva
  - Altura ajustable
- FR**
  - Cassette élégante avec caches chromés
  - Apparence exclusive
  - Hauteur réglable



Art. nr.	☒	Dimensions (cm)		
		W	H	KG
RBP085	○	85	160-220	5,7
RBP100	○	100	160-220	6,8
RBP120	○	120	160-220	8,3
RBP150	○	150	160-220	10
RBPB085	●	85	160-220	5,7
RBPB100	●	100	160-220	6,8

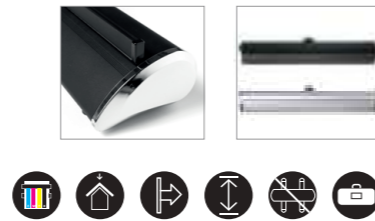

### ROLL-BANNER PREMIUM CLAMP

- IT**
  - Possibilità di cambiare grafica facilmente
  - Altezza regolabile
  - Cassetta elegante con tappi laterali a forma di goccia
- ES**
  - Facilita todavía más el cambio de gráfica
  - Altura ajustable
  - La base elegante con tapas laterales en forma de lágrima
- FR**
  - Possibilité de changer facilement le graphique
  - Hauteur réglable
  - Cassette élégante avec embouts latéraux en forme de goutte d'eau



Art. nr.	Dimensions (cm)		
	W	H	KG
RBPC085	85	160-225	5,5
RBPC100	100	160-225	5,7

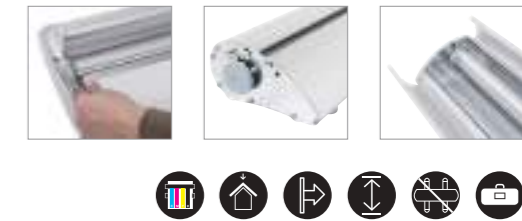

☒ Change graphics with graphic including the alu strip

### ROLL-BANNER MASSIVE

- IT**
  - Piedini in alluminio massiccio
  - Altezza regolabile
  - Solido, robusto e di estrema durata
- ES**
  - Pies de aluminio macizo
  - Altura ajustable
  - Fuerte, robusto y muy duradero
- FR**
  - Pieds massifs en aluminium
  - Hauteur réglable
  - Solide, résistant et extrêmement durable



Art. nr.	Feet	Dimensions (cm)		
		W	H	KG
RBMAS085	1	85	160-220	4,1
RBMAS100	1	100	160-220	5



☒ See accessories page for options (p. 232)

### ROLL-BANNER DELUXE

- IT**
  - Banner di durata estrema con finitura elegante
  - Porta Banner Roll Up con facile sostituzione della grafica
  - Altezza regolabile
- ES**
  - Banner extremadamente duradero con un acabado elegante
  - Banner enrollable con fácil cambio de gráfica
  - Altura ajustable
- FR**
  - Bannière extrêmement durable avec une finition élégante
  - Roll-Banner avec changement simple du visuel
  - Hauteur réglable



Art. nr.	Dimensions (cm)		
	W	H	KG
RBL085	85	160-225	5,3
RBL100	100	160-225	6



☒ Change graphics with graphic including the alu strip

☒ Available in 3 types of graphic materials (see p. 302 - 303)

☒ See accessories page for options (p. 234)

### ROLL-BANNER TWIN

- IT**
  - Banner bifacciale
  - Il palo è invisibile tra le due grafiche
  - Vano aggiuntivo per alloggiamento del palo nella custodia
- ES**
  - Banner de doble cara
  - Poste invisible entre las dos impresiones
  - Compartimiento extra de almacenamiento para el poste en la bolsa
- FR**
  - Bannière double-face
  - Le mât est invisible entre deux visuels
  - Compartiment supplémentaire pour le rangement des mâts dans le sac

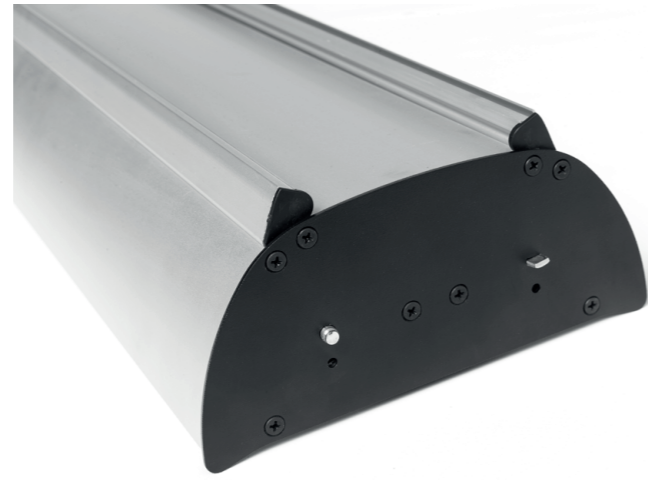

Art. nr.	Dimensions (cm)		
	W	H	KG
RBTW085	85	200	4,6
RBTW100	100	200	5,2



### ROLL-BANNER EXTREME

- IT**
  - Cassetta ampia e alta
  - Stabile, fisso ed estremamente robusto
  - Altezza regolabile
- ES**
  - Base ancha
  - Estable, firme y extremadamente robusto
  - Altura ajustable
- FR**
  - Grande et lourde cassette
  - Stable, ferme et extrêmement robuste
  - Réglable en hauteur



Art. nr.	Dimensions (cm)		
	W	H	KG
RBEX150	150	170-270	9,8
RBEX200	200	170-300	11,6

- Available in 1 type of graphic material (see p. 302 - 303)
- Graphic material Symbio Banner

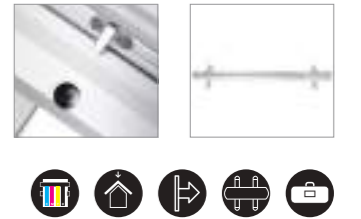

### ROLL-BANNER DOUBLE

- IT**
  - Banner bifacciale professionale prestigioso
  - Estremamente stabile grazie all'ampia cassetta pesante
  - Sta completamente in posizione verticale
- ES**
  - Banner de doble cara de lujo y profesional
  - Extremadamente estable debido a la fuerte y amplia base
  - Se mantiene completamente erguido
- FR**
  - Bannière professionnelle de luxe double-face
  - Extrêmement stable grâce à la large et lourde cassette
  - Se tient complètement droit



Art. nr.	Dimensions (cm)		
	W	H	KG
RBD085	85	200	6,6
RBD100	100	200	7,6



### ROLL-BANNER OPEN-AIR

- IT**
  - Banner bifacciale per uso esterno
  - Sicuro e stabile
  - Cassetta in alluminio pesante
- ES**
  - Baner doble cara para uso en exteriores
  - Seguro y estable
  - Base de aluminio resistente
- FR**
  - Bannière double-face pour utilisation en extérieur
  - Sécurisée et stable
  - Cassette en aluminium pour utilisation intensive



Art. nr.	Dimensions (cm)		
	W	H	KG
RBOA085	85	200	9,1

- Available in 2 types of graphic material (see p. 302 - 303)
- Graphic material Symbio Banner



## BANNER OUTDOOR

- IT**
  - Regolabile in altezza con clip in alluminio
  - Supporto banner in vetroresina
  - Cambio grafica semplice e veloce
- ES**
  - Ajustable en altura con clip de aluminio
  - Soporte de banner de fibra de vidrio
  - Impresión rápida y fácil de cambiar
- FR**
  - Hauteur réglable avec clip en aluminium
  - Porte-baneroles en fibre de verre
  - Changement rapide et facile du visuel



Art. nr.      Dimensions (cm)

	W	H	KG
OB180	80	180	4

Graphic available

Roll-Banner Challenger (p. 211/ch. 15), Postersnapper (p. 26/ch. 1), Micro Flag (p. 236/ch. 16), Natura Table Top Chalk Board (p. 126/ch. 7)



## L-BANNER QUICK

- IT**
  - Un'alternativa elegante ai Porta Banner Roll Up
  - Banner con montaggio rapido
  - Cambio grafiche semplice e veloce
- ES**
  - Una alternativa inteligente para Roll-Banner
  - Banner con configuración rápida
  - Rápido y fácil cambio de impresiones
- FR**
  - Une alternative intelligente pour les Roll-Banners
  - Bannière avec configuration rapide
  - Changement rapide et facile des visuels



Art. nr.      Dimensions (cm)

	W	H	KG
LBQ080	80	200	1,3

Single-piece cardboard packaging not standard included

## L-BANNER TELESCOPIC

- IT**
  - Banner prestigioso con finitura elegante
  - Altezza regolabile
  - Attacco e cambio stampa facili
- ES**
  - Bandera de lujo con elegante acabado
  - Altura ajustable
  - Enlace dos sistemas con el conector opcional L-Banner
- FR**
  - Bannière de luxe avec finition élégante
  - Hauteur réglable
  - Interconnectez deux systèmes avec le connecteur L-Banner en option



Art. nr.      Dimensions (cm)

	W	H	KG
LB080	80	160 - 220	2,4
LB085	85	160 - 220	2,5

Single-piece cardboard packaging not standard included

Available in 2 types of graphic materials (see p. 302 - 303)

See accessories page for options (p. 232)

### X-BANNER BUDGET

- IT**
  - Facile e veloce da assemblare
  - Sistema a malapena visibile
  - L'alternativa più conveniente a un Porta Banner Roll Up
- ES**
  - Rápido y fácil de montar
  - Sistema apenas visible
  - Alternativa más rentable para un Roll-Banner
- FR**
  - Rapide et facile à assembler
  - Système à peine visible
  - Alternative la plus économique pour un Roll-Banner



Art. nr.	Dimensions (cm)		
	W	H	KG
XBB60-160	60	160	0,4
XBB80-180	80	180	0,4
XBB80-200	80	200	0,4



Single-piece cardboard packaging not standard included

### X-BANNER PREMIUM

- IT**
  - Treppiede in alluminio con sommità in fibra
  - Cambio grafiche semplice e veloce
  - Sistema a malapena visibile
- ES**
  - Trípode de aluminio con tapas de fibra
  - Cambio rápido y fácil de impresiones
  - Sistema apenas visible
- FR**
  - Trépied en aluminium avec dessus en fibre
  - Changement rapide et facile des visuels
  - Système à peine visible



Art. nr.	Dimensions (cm)		
	W	H	KG
XBP060	60	160	1,3
XBP080	80	180	1,4
XBP100	100	200	1,6



Single-piece cardboard packaging not standard included

Available in 2 types of graphic materials (see p. 302 - 303)

See accessories page for options (p. 234)

### INTERLOCKING BASE

- IT**
  - Soluzione pannello autoportante economico
  - I pannelli possono essere ancorati al supporto
  - Cartello ideale per negozi
- ES**
  - Solución económica para panel publicitario
  - Paneles con orificios en la parte inferior para fijación segura con tornillos
  - Publicidad ideal para tiendas
- FR**
  - Solution économique de panneau sur pied
  - Panneaux percés dans la partie inférieure pour fixer les boulons de sécurité
  - Panneau d'affichage idéal en magasin

now available with print →



Art. nr.	DIN/Size	Dimensions (cm)			
		W	H	D	KG
BH60	60	60	18	54	8,2
BH80	80	80	18	54	11,1



Perfect for use of BOND panels

### PANEL BASE ALUMINIUM

- IT**
  - Base in alluminio stabile con piedini in silicone antiscivolo
  - Adatta a pannelli spessi da 3 a 26 mm
  - Ideale da utilizzare come cartello per negozi
- ES**
  - Base de aluminio estable con pies de silicona antideslizantes
  - Adecuado para paneles de 3 a 26 mm de espesor
  - Ideal para usar en tiendas
- FR**
  - Base stable en aluminium avec pieds en silicone antidérapant
  - Convient aux panneaux de 3 à 26 mm d'épaisseur
  - Idéal comme panneau d'affichage d'un magasin

now available with print →



Art. nr.	Ø	Dimensions (cm)			
		W	H	D	KG
PBAS30	●	30	14	38	7
PBAS50	●	50	14	38	10
PBAB30	●	30	14	38	7
PBAB50	●	50	14	38	10



Perfect for use of BOND panels

Graphic available



now available  
with print →

## PANEL BASE STEEL

- IT**
- Espositore ideale per negozi
  - Elegante base in acciaio nero
  - Piedini in silicone antiscivolo
- ES**
- Señalización ideal para tiendas
  - Base elegante de acero de color negro
  - La base con pies de silicona antideslizante
- FR**
- Enseigne idéale pour les magasins
  - Élégant socle en acier noir
  - Pieds en silicone antidérapants

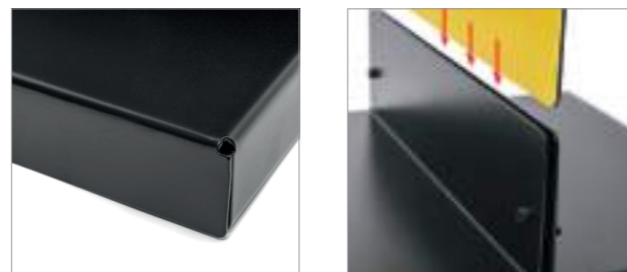

Art. nr.	Dimensions (cm)			
	W	H	D	KG
PBS400x400C9005	40	4	41,4	5

Perfect for use of BOND panels



222 Graphic available



BESTSELLER



also with eco print material

## ZIPPER-BANNER SLIM

- IT**
- Ottima alternativa al Porta Banner Roll Up standard
  - Rivestimento in tessuto senza pieghe su un lato o bifacciale
  - Sistema a scatto facile da montare
- ES**
- Una gran alternativa para el Roll Banner estándar
  - Individual o doble cara, con sistema antiarrugas
  - Fácil de montar con sistema de clic
- FR**
- Excellente alternative au roll-up standard
  - Revêtement en tissu infroissable sur une ou deux faces
  - Système clic-clac facile à assembler



Art. nr.	Dimensions (cm)		
	W	H	KG
ZBSLIM080-200	80	200	2,4
ZBSLIM085-200	85	200	2,6
ZBSLIM100-200	100	200	2,9



224 Graphic available

## ZIPPER-WALL BANNER

- IT**
- Lussuoso banner bifacciale con rivestimento in tessuto anti piega
  - Con base nera in acciaio
  - Può essere completamente smontato per facilitare il trasporto
- ES**
- Banner de doble cara de lujo con tela lisa y sin arrugas
  - Con base de acero negro
  - Completamente desmontable para un fácil transporte
- FR**
- Bannière double face luxueuse avec revêtement en tissu sans plis
  - Avec base en acier noir
  - Peut être entièrement démontée pour faciliter le transport



Art. nr.	Dimensions (cm)			
	W	H	D	KG
ZWB080-200	80	200	25	8,3
ZWB100-200	100	200	25	9,9

- Optional: LED Lighting and Clamp Tube (see chapter 18. Walls (p. 287))
- Graphic available





## ZIPPER-BANNER COBRA

- IT**
- Bannière durable avec visuel en tissu aux couleurs vives
  - Visuel sans PVC avec keder en 100 % polyester recyclé sur les côtés
  - Léger et facile à transporter
- ES**
- Forma innovadora destacable
  - Montaje fácil y rápido sin necesidad de herramientas
  - Maletín de transporte lujoso incluido
- FR**
- Format original qui sort du lot
  - Montage facile et rapide grâce à l'assemblage sans outils
  - Inclus un luxueux sac de transport souple



Art. nr.	Dimensions (cm)			
	W	H	D	KG
ZBCOBRA	91,5	226	75	3,5



## BANNER STAND RUSTIC

- IT**
- Banner di lunga durata con una grafica in tessuto vivace
  - Grafica senza PVC con profili in PES 100% riciclato ai lati
  - Leggero e facile da trasportare
- ES**
- Banner duradero con gráfico de tejido vivo
  - Gráfica sin PVC con keder reciclado de 100% PES en los laterales
  - Ligero y fácil de transportar
- FR**
- Bannière durable avec visuel en tissu aux couleurs vives
  - Visuel sans PVC avec keder en 100 % polyester recyclé sur les côtés
  - Léger et facile à transporter



Art. nr.	Dimensions (cm)			
	W	H	D	KG
WBS085	91	200	28	4,4



## ZIPPER-BANNER TRIANGLE

- IT**
- Leave a giant impression with a height of almost 2,6 m
  - Flag and banner in one
  - Double-sided fabric display with innovative shape
- ES**
- Cause una impresión de gran impacto con altura de casi 2,6 m
  - Banner y bandera en uno
  - Display de tela de doble cara con una forma innovadora
- FR**
- Laissez une méga-impression avec une hauteur de près de 2,6 m
  - Drapeau et bannière en un seul produit
  - Présentoir en tissu double face à la forme innovante



Art. nr.                      Dimensions (cm)

	W	H	D	KG
ZWBT-L	108	255,3	50	6,7





**BANNER PROFILE**

- IT**
  - Sospensione sicura di banner in formati grandi e pesanti
  - Profilo a presa in alluminio per materiale di peso 400 - 750 g/m<sup>2</sup>
  - Cambio banner rapido e semplice
- ES**
  - Suspensión segura para pósters pesados y de gran formato
  - Perfil de sujeción de aluminio que soporta 400 - 750 g/m<sup>2</sup> del material
  - Cambio de póster rápido y fácil
- FR**
  - Suspension sûre des bannières lourdes et de grand format
  - Profil de pincement en aluminium pour matériau de poids de 400 - 750 g/m<sup>2</sup>
  - Changement facile et rapide de bannières

Art. nr.	Dimensions (cm)			
	W	H	D	KG
BP100	100,5	2,5	1,5	0,8
BP120	120,5	2,5	1,5	0,9
BP180	180,5	2,5	1,5	1,4
BP300	300,5	2,5	1,5	2,3
BP50	50,5	2,5	1,5	0,4
BP60	60,5	2,5	1,5	0,5
BP70	70,5	2,5	1,5	0,5
BP80	80,5	2,5	1,5	0,6
BP85	85,5	2,5	1,5	0,6

Optional: Frame Hanging Kit (see p. 232)



**ZIP-UP ROUND AND SQUARE**

- IT**
  - Porta banner sospeso per la massima esposizione
  - Telaio tubolare in alluminio leggero
  - Installazione passo-passo rapida e facile
- ES**
  - Banner colgante para una máxima exposición
  - Estructura ligera de aluminio tubular
  - Instalación rápida y fácil paso a paso
- FR**
  - Bannière suspendue pour une exposition maximale
  - Cadre tubulaire léger en aluminium
  - Installation étape par étape rapide et facile

Art. nr.	Dimensions (cm)				
	Ø	W	H	D	KG
<b>Round</b>					
ZURS	152		61		6,7
ZURL	305		76		11
<b>Square</b>					
ZUSM		244	107	244	12,4

Single-sided and double-sided graphics available



### LENGTHENING POLE

Accessory for Roll-Banner Basic



- IT** • Palo allungabile di 20 cm in altezza
- ES** • Poste alargador de 20 cm de altura
- FR** • Poteau de rallonge de 20 cm de hauteur

Art. nr. P20RBBAS ●

### BANNER LED

Accessory for all Roll-Banners



- IT** • LED luminosi
- ES** • Adecuado en otros sistemas con el 'Banner Light Clip' opcional
- FR** • Convient aux autres systèmes avec le 'Banner Clip Light' en option

Art. nr. BLED3B ●  
BLED3S ●

### LUXURIOUS LIGHT BAG

Accessory for Banner LED



- IT** • Adatto ad alloggiare 3 luci
- ES** • Adecuado para almacenar 3 luces
- FR** • Adapté au stockage de 3 éclairages

Art. nr. L-BAG-M

### FRAME HANGING KIT

Accessory for Banner Profile



- IT** • Kit di montaggio o sospensione da soffitto
- ES** • Juego de suspensión o suspensión del techo
- FR** • Kit de suspension ou suspension au plafond

Art. nr. HSKR



## 16. FLAGS

Bandiere  
Banderas  
Drapeaux

Flags are a great way to get people's attention in both indoor and outdoor settings. Flags are a popular choice among petrol stations, car companies, restaurants, retail shops, shopping centres and sport events. Quick and easy to set up and visible from a distance. Available in a variety of shapes and sizes.

- GRAPHIC AVAILABLE TO CUSTOMISE YOUR FLAG
- WIDE RANGE OF DESIGNS AND COMBINATIONS
- GREAT SOLUTION FOR EVERY SITUATION, INDOOR OR OUTDOOR

### INDEX

16.1 Indoor Flags <i>Bandiere da interno Banderas para Interior Drapeaux intérieur</i>	<b>236</b>
16.2 Outdoor Flags <i>Bandiere da esterno Banderas para Exterior Drapeaux d'extérieur</i>	<b>240</b>
16.3 Accessories <i>Accessori Accesorios Accessoires</i>	<b>246</b>

### ✓ GOOD BEACH FLAG BUDGET WIND

- Economic flag with great quality
- One system for two shapes
- Suitable for both wind and drop shaped flags

### 👍 BETTER BEACH FLAG FIBER WIND

- One system for three shapes
- Suitable for wind, drop and paddle shaped flags
- Flexible fiberglass flag pole

### 🏆 BEST BEACH FLAG ALU WIND

- Most popular Beach Flag
- Fits everywhere, from gas stations to shopping centres and events
- Thick aluminium flag pole, Ø 28 mm





## MICRO FLAG

- IT**
- Elegante bandiera da tavolo con base in alluminio
  - Bandiera classica a forma di goccia su un lato o bifacciale
  - Assemblaggio rapido e semplice
- ES**
- Tableros elegantes con base de aluminio
  - Bandera en forma pluma clásica a una o dos caras
  - Montaje fácil y rápido
- FR**
- Élégant présentoir de table avec base en aluminium
  - Drapeau en forme de goutte, simple et double face - Forme classique
  - Installation facile et rapide

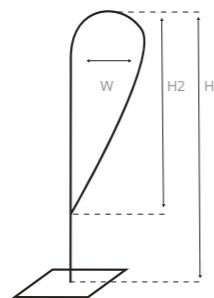

Art. nr.	Dimensions (cm)			
	Flag size: W	Pole height: H1	Flag size: H2	KG
BFMIC60	23	45	8	0,1

- Ideal for brand promotion at car dealers, shops or exhibition booths
- Single-sided and double-sided graphics available

## WINDOW FLAG WIND & DROP

- IT**
- Configurazione rapida e semplice con angolazione regolabile
  - Elegante design nero con ventosa bloccabile sofisticata
  - Un sistema adatto a bandiere sia a vela sia a goccia
- ES**
- Montaje fácil y rápido con un ángulo ajustable
  - El diseño negro elegante con un sistema sofisticado de ventosa con cierre
  - El mismo sistema compatible con ambas variantes, tanto con la bandera en forma de vela como con la bandera en forma de gota
- FR**
- Installation facile et rapide avec un angle réglable
  - Conception noire élégante avec une ventouse sophistiquée
  - Un seul système convenant à la fois aux drapeaux flottants et en forme de goutte



Art. nr.	Dimensions (cm)			
	Flag size: W	Pole height: H1	Flag size: H2	KG
WINFLAG (wind shape)	24	92	67	0,1
WINFLAG (drop shape)	28	78	50	0,1



- For both indoor and outdoor use
- Single-sided and double-sided graphics available



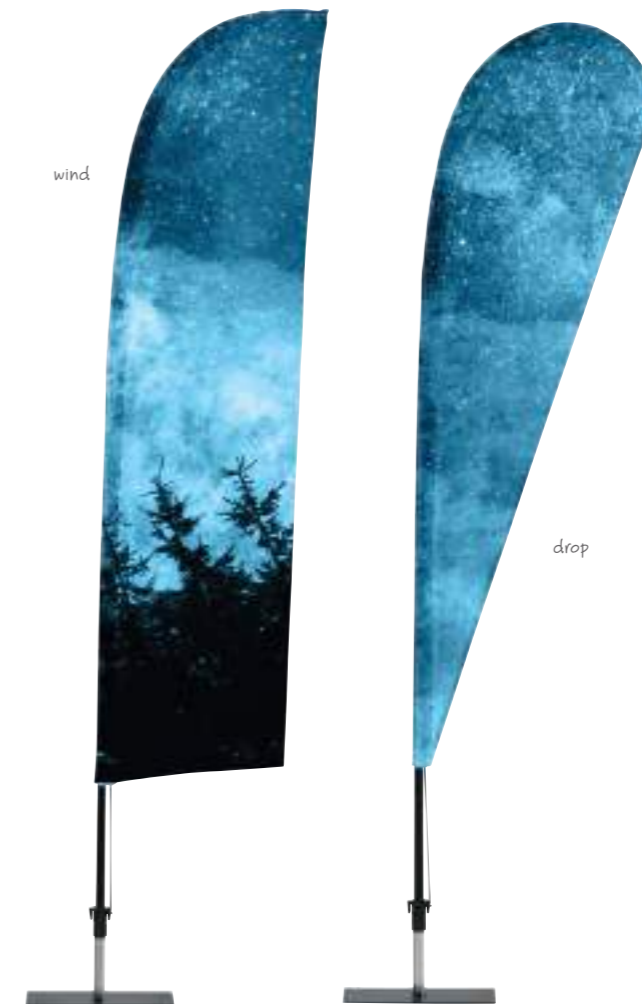

## PROMO FLAG WIND & DROP

- IT**
- Bandiera indoor professionale
  - Sistema a scatto facile da montare
  - Piastra in acciaio nero opaco con supporto rotatore incluso
- ES**
- Bandera profesional de interior
  - Sistema de clic fácil de montar
  - Placa de acero negro mate con soporte giratorio incluido
- FR**
- Drapeau d'intérieur professionnel
  - Système clic-clac facile à assembler
  - Plaque en acier noir mat avec support de rotateur inclus

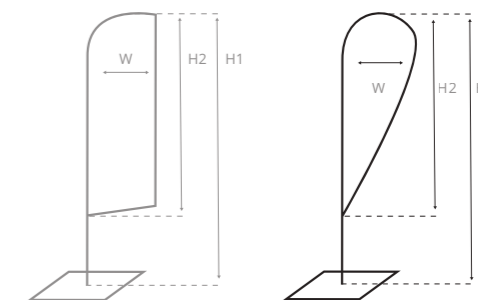

Art. nr.	Dimensions (cm)			
	Flag size: W	Pole height: H1	Flag size: H2	KG
PROFLAG (wind shape)	42	205	163	2,4
PROFLAG (drop shape)	49	196	150	2,4

🔧 Steel base included





## BEACH FLAG BUDGET WIND & DROP

- IT**
- Beach flag economica di grande qualità
  - Un sistema per due forme
  - Adatto a bandiere sia a vela sia a goccia
- ES**
- Bandera económica de gran calidad
  - Un sistema para dos formas
  - Apto para banderas con forma de viento y de gota
- FR**
- Drapeau économique de grande qualité
  - Un système pour deux formes
  - Convient aux drapeaux en forme classique et forme de goutte

Art. nr.	Dimensions (cm)			
	Flag size:		Pole height:	
	W	H1	H2	KG
<b>Wind</b>				
BFB-S	56,9	248	202,6	0,4
BFB-M	62	301,5	268	0,5
BFB-L	81,5	399	336,5	0,6
BFB-XL	87,6	499	460	1
<b>Drop</b>				
BFB-S	78	215,5	178	0,4
BFB-M	97,5	259,5	211	0,5
BFB-L	112	337	275	0,6
BFB-XL	122	435	366	1

- ❗ Base with 17 mm rotator is not included
- ➕ Optional: Luxurious Padded Transporter Bag (see p. 246)



➕ Beach Flag Bases see (p. 246 and 247)

## BEACH FLAG BUDGET SQUARE

- IT**
- Beach flag economica di grande qualità
  - Grande area grafica visiva
  - Palo in alluminio
- ES**
- Bandera económica de gran calidad
  - Gran superficie para su diseño
  - Mástil de aluminio
- FR**
- Drapeau économique de grande qualité
  - Grande zone graphique visuelle
  - Poteau en aluminium

Art. nr.	Dimensions (cm)			
	Flag size:		Pole height:	
	W	H1	H2	KG
BFBS-S	62	180	97	0,6
BFBS-M	62	235	152	0,7
BFBS-L	75	343,5	256	1
BFBS-XL	86,5	440	351	1,3

- ❗ Base with 17 mm rotator is not included
- ➕ Beach Flag Bases see (p. 246 and 247)
- ➕ Optional: Luxurious Padded Transporter Bag (see p. 246)
- ➕ Graphic available

Beach Flag Alu Paddle (p. 242/ch. 16)



request a free graphic visualisation



single-sided version also with eco print material



one system for two shapes

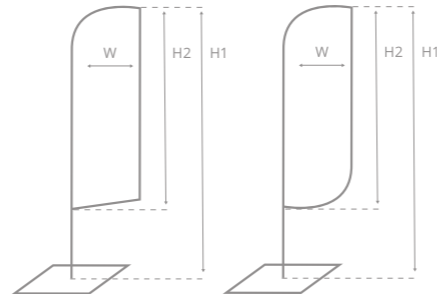

## BEACH FLAG ALU WIND & PADDLE

- IT**
- La bandiera più venduta
  - Adatta ovunque, dalle stazioni di servizio ai centri commerciali e agli eventi
  - Palo bandiera in alluminio spesso, Ø 28 mm
- ES**
- La bandera más popular
  - Se adapta a todas partes, desde estaciones de servicio hasta centros comerciales y eventos
  - Mástil grueso de aluminio, Ø 28 mm
- FR**
- Beach Flag le plus populaire
  - Convient partout, des stations-service aux centres commerciaux et aux événements
  - Poteau de pavillon en aluminium épais, Ø 28 mm

Art. nr.	Dimensions (cm)			
	Flag size: W	Pole height: H1	Flag size: H2	KG
BFAW205	86	192	162	0,8
BFAW255	86	242	192	0,9
BFAW310	86	295	233	1,1
BFAW360	86	351	284	1,2
BFAW415	86	400	337	1,5
BFAW465	86	455	388	1,8
BFAW520	86	511	439	2

- ❶ Base with 25 mm rotator is not included
- ❷ Optional: Luxurious Padded Transporter Bag (see p. 246)

## BEACH FLAG ALU DROP

- IT**
- Aspetto lussuoso con palo bandiera verniciato a polvere nero
  - Sempre tesa grazie alla forma a goccia
  - Palo bandiera in alluminio spesso, Ø 28 mm
- ES**
- Aspecto elegante con una bandera con mástil recubierto en color negro
  - Siempre tensado gracias a la forma de la gota
  - Mástil grueso de aluminio, Ø 28 mm
- FR**
- Aspect luxueux avec mât de pavillon thermolaqué noir
  - Toujours serré grâce à la forme de goutte
  - Mât de pavillon en aluminium épais, Ø 28 mm

Art. nr.	Dimensions (cm)			
	Flag size: W	Pole height: H1	Flag size: H2	KG
BFAD235	84	225	183	0,9
BFAD290	84	276	236	1,2
BFAD345	84	330	281	1,4
BFAD400	105	390	325	1,6
BFAD520	124	503	425	2

- ❶ Base with 25 mm rotator is not included
- ❷ Optional: Luxurious Padded Transporter Bag (see p. 246)

## BEACH FLAG ALU SQUARE

- IT**
- Grande area grafica visiva
  - Forma facile da progettare
  - Palo bandiera in alluminio spesso, Ø 28 mm
- ES**
- Gran área gráfica visual
  - Forma fácil de diseñar
  - Mástil grueso de aluminio, Ø 28 mm
- FR**
- Grande zone graphique visuelle
  - Forme facile à créer
  - Poteau indicateur en aluminium épais, Ø 28 mm

Art. nr.	Dimensions (cm)			
	Flag size: W	Pole height: H1	Flag size: H2	KG
BFAS240	60	229	151	1,3
BFAS350	84	336	260	1,8
BFAS460	84	444	372	2,24

- ❶ Base with 25 mm rotator is not included
- ❷ Optional: Luxurious Padded Transporter Bag (see p. 246)

request a free graphic visualisation



single-sided version also with eco print material

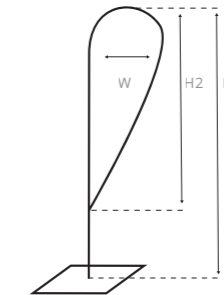

request a free graphic visualisation



single-sided version also with eco print material

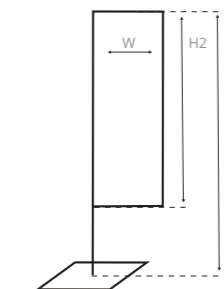



single-sided version also with eco print material



## BEACH FLAG FIBER DROP, WIND & PADDLE

- IT**
- Un sistema per tre forme
  - Adatto a bandiere sia a vela sia, a Paddle e a goccia
  - Materiale di stampa Eco disponibile
- ES**
- Un sistema con tres formas
  - Adecuado para banderas con forma Vela, Paddle y Gota
  - Mástil de fibra de vidrio flexible
- FR**
- Un système pour trois formes
  - Convient aux drapeaux flottants, Paddle et en forme de goutte
  - Hampe de drapeau en fibre de verre flexible

Art. nr.	Dimensions (cm)			
	Flag size: W	Pole height: H1	Flag size: H2	KG
<b>Drop</b>				
BFF-S	56	171	136	0,5
BFF-M	65	218	175	0,7
BFF-L	109	282	231	0,9
BFF-XL	135	399	361	1,2
<b>Wind &amp; Paddle</b>				
BFF-S	46	196	151	0,5
BFF-M	65	249	189	0,7
BFF-L	77	343	278	0,9
BFF-XL	78	471	394	1,2

- ⓘ Base with 25 mm rotator is not included
- ⊕ Optional: Luxurious Padded Transporter Bag (see p. 246)

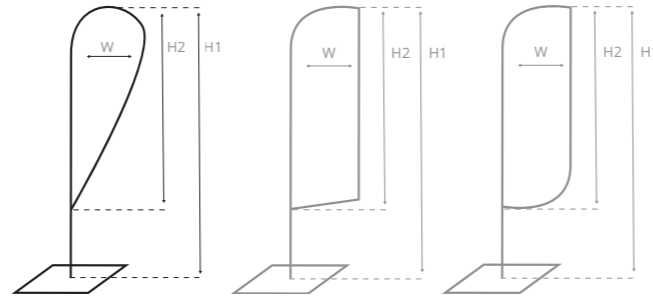

⊕ Beach Flag Bases see (p. 246 and 247)

## FLAG POLE 540

- IT**
- Sistema bandiera estremamente grande
  - Base con quattro gambe in alluminio
  - Base stabile composta da due parti
- ES**
- Sistema de bandera extremadamente grande
  - Base de 4 patas de aluminio
  - Base estable de dos partes
- FR**
- Très grand système pour drapeau
  - Base en aluminium à 4 pattes
  - Base stable en deux parties



Art. nr.	Base ∅	Dimensions (cm)			Flag size: KG
		Flag size: W	Pole height: H1	Flag size: H2	
FP540	80 x 80	110	540	330	Tank: 10 Pole: 6,5

\*1 system fits in 2 boxes. 2 systems fit in 3 boxes.  
Tanks always packed in a separate box. Poles per 2 in 1 box.

- ⓘ Including extra weight for down force flag



## FLAG POLE CLASSIC GRAPHIC

- IT**
- Disponibile in 3 larghezze e 2 altezze
  - Facile da installare con moschettoni
  - Promozione esterna economica monofacciale
- ES**
- Disponible en 3 anchos y 2 alturas
  - Fácil de instalar con mosquetones
  - Promoción exterior asequible a una sola cara
- FR**
- Disponible en 3 largeurs et 2 hauteurs
  - Facile à installer avec des mousquetons
  - Promotion extérieure simple face à petit prix

Art. nr.	Dimensions (cm)		
	W	H	KG
FPC100x300G	108	300	0,4
FPC100x400G	108	400	0,5
FPC120x300G	128	300	0,5
FPC120x400G	128	400	0,6
FPC150x300G	158	300	0,6
FPC150x400G	158	400	0,8

- ⓘ Hardware must be sourced externally

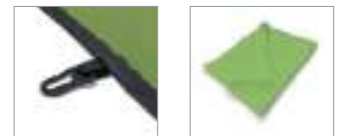

⊕ Graphic available

### LUXURIOUS PADDED TRANSPORTER BAG

Accessory for multiple Beach Flags



- IT** • Borsa da trasporto imbottita lussuosa per molteplici bandiere da spiaggia
- ES** • Bolsa de transporte acolchada de lujo para múltiples productos beachflag
- FR** • Sac de transport design et renforcé pouvant être utilisé pour différents beachflags

Art. nr. Suitable for BFF-M  
AP-BF-BAG-LUXL

Suitable for all Beach Flags, except BFF-M  
AP-BF-BAG-LUXXL

### GROUND-DRILL

Accessory for Alu and Fiber Flags  
17 mm for Budget Flags  
25 mm for Alu and Fiber Flags



- IT** • Base perfetta per terreno solido
- ES** • Base perfecta para terreno sólido
- FR** • Base parfaite pour terrain compact

Art. nr. For Budget Flags  
BF-GD-17

For Alu and Fiber Flags  
BF-GD

### GROUND-PIN

Accessory for all Beach Flags  
17 mm for Budget Flags  
25 mm for Alu and Fiber Flags



- IT** • Base adatta a un terreno compatto e semicompatto
- ES** • Base adaptée pour un sol compact et semi-compact
- FR** • Base adecuada para terrenos compactos y semi-compacto

Ground-Pin 60

Art. nr. For Budget Flags  
BF-GP-17 Ground-Pin 60  
Ground-Pin 80

For Alu and Fiber Flags  
BF-GP60  
BF-GP80

### CAR-FOOT

Accessory for all Beach Flags  
17 mm for Budget Flags  
25 mm for Alu and Fiber Flags



- IT** • Adatto ad aree interne ed esterne
- ES** • Adecuado para uso en interiores y al aire libre
- FR** • Convient à une utilisation à l'intérieur et à l'extérieur

Art. nr. For Budget Flags  
BF-CF-17

For Alu and Fiber Flags  
BF-CF

### LUXURIOUS STEEL PLATE

Accessory for all Beach Flags  
17 mm for Budget Flags  
25 mm for Alu and Fiber Flags



- IT** • Base elegante con rotatore cromato incluso
- ES** • Base elegante con rotador incluido
- FR** • Socle élégant avec rotateur chromé inclus

Art. nr. For Budget Flags  
BF-ST6-17 Steel Plate 6 kg  
BF-ST12-17 Steel Plate 12 kg

For Alu and Fiber Flags  
BF-ST6 Steel Plate 6 kg  
BF-ST12 Steel Plate 12 kg  
BF-ST20 Steel Plate 20 kg  
BF-ST12.20BAG Steel Plate 12 / 20 kg bag

### WATER TANK

Accessory for all Beach Flags  
17 mm for Budget Flags  
25 mm for Alu and Fiber Flags



- EN** • Perfetta e adatta a tutte le superfici piane
- ES** • Perfecto para todas las superficies planas
- FR** • Parfait pour toutes les surfaces planes

Art. nr. For Budget Flags  
BF-WT21-17 Water Tank 21 liter

For Alu and Fiber Flags  
BF-WT21 Water Tank 21 liter  
BF-WT24 Water Tank 24 liter

Natura Chalk Fast-Switch A-Board (p. 119/ch. 7), and Beach Flag Alu Drop (p. 243/ch. 16)



### CROSS-BASE

Accessory for all Beach Flags  
17 mm for Budget Flags  
25 mm for Alu and Fiber Flags



- IT** • Una base leggera particolarmente adatta a un utilizzo interno
- ES** • Una base ligera que es más adecuada para uso en interiores
- FR** • Base légère qui convient principalement à une utilisation en intérieur

Art. nr. For Budget Flags  
BF-CB30-17 Cross-Base 30

For Alu and Fiber Flags  
BF-CB30 Cross-Base 30  
BF-CB50 Cross-Base 50

### WATER BAG

Accessory for Cross-Base



- IT** • Perfetta per migliorare la stabilità delle bandiere
- ES** • Perfecto para mejorar la estabilidad de las banderas
- FR** • Parfait pour améliorer la stabilité des drapeaux

Art. nr. BF-WB  
BF-WB-ECO **NEW**

### SAND BAG

Accessory for Cross-Base



- IT** • Perfetta per migliorare la stabilità delle bandiere
- ES** • Perfecto para mejorar la estabilidad de las banderas
- FR** • Parfait pour améliorer la stabilité des drapeaux

Art. nr. BF-SB

## 17. COUNTERS AND TABLE COVERS

**Banchette e tovaglie**  
**Mostradores y Cubiertas de Mesa**  
**Comptoirs et Housses de Table**

Counters and Table Covers are very effective for communication and presentation during exhibitions and events. They are portable, easy to assemble without tools, provide full-colour graphics on the outside and storage space on the inside. You'll stay organised and look professional. Go for a well-dressed Table Cover to improve a company presentation at business conventions, hotel events, job fairs and much more. Setting up your promotional stand has never been so quick and easy.

### INDEX

17.1 Counters and Accessories **250**  
*Banchetti e accessori*  
*Mostradores y Accesorios*  
*Comptoirs et Accessoires*

17.2 Table Covers **264**  
*Tovaglie*  
*Cubiertas de Mesa*  
*Housses de Table*

- **QUICK AND EASY TO ASSEMBLE**
- **DIFFERENT SHAPES AND SIZES AVAILABLE**
- **GRAPHIC AVAILABLE TO CUSTOMISE YOUR COUNTER OR TABLE COVER**



### ✓ GOOD COUNTER PROFESSIONAL ORIGINAL M

- Extremely stable because of curved shape
- Quick and easy to assemble
- Optional Plastic Shelf

### 👍 BETTER COUNTER IMPRESS

- Aluminium frame that holds Silicone Edge Graphics
- Equippable with LED-curtains for an eye-catching backlit effect
- One system suitable for with or without LED curtains

### 🏆 BEST DIGITAL COUNTER FUTURO

- Premium counter with a digital presentation in landscape or portrait
- Easy to assemble
- Standard with black graphics on the sides (SEG)

GET THE FULL EXPERIENCE AND GO TO WWW.DIGITAL-COUNTER.COM

BESTSELLER



## DIGITAL COUNTER FUTURO

- IT**
  - Comptoir premium avec affichage digital en orientation paysage ou portrait
  - Assemblage facile
  - Modèle standard avec visuels noirs latéraux (SEG)
- ES**
  - Mostrador premium con presentación digital en orientación horizontal
  - Fácil de montar
  - De serie con gráficos negros en los laterales (SEG)
- FR**
  - Comptoir premium avec affichage numérique en orientation paysage
  - Assemblage facile
  - Modèle standard avec visuels noirs latéraux (SEG)



Art. nr.	Icon	Inch	Dimensions (cm)			
			W	H	D	KG
DICOUNTER32ESF	●	32"	72	92,8	44,5	23,1
DICOUNTER55ESF	●	55"	92,8	134,5	40,5	45,5
DICOUNTER32C9003ESF	○	32"	72	92,8	44,5	23,1



## COUNTER BOUNCEUP

- IT**
  - Assemblaggio semplice e veloce senza bisogno di attrezzi con un sistema a molla
  - Con o senza illuminazione LED
  - Top nero con scanalatura per posizionare facilmente la grafica SEG
- ES**
  - Montaje rápido y fácil sin herramientas gracias al sistema de resorte
  - Con o sin iluminación LED
  - Mesa superior negra con ranura para fácil colocación de gráficos SEG
- FR**
  - Assemblage rapide et facile sans outil grâce au système de ressorts
  - Avec ou sans éclairage LED
  - Plateau noir avec rainure pour faciliter la mise en place des visuels SEG

Art. nr.	Dimensions (cm)			
	W	H	D	KG
CBUTTB	80	101	40	12,9
CBUTTB-LED	80	101	40	13,8

- Including soft bag for easy transport
- 6500 K colour temperature and Edge lit 24V LED Lights

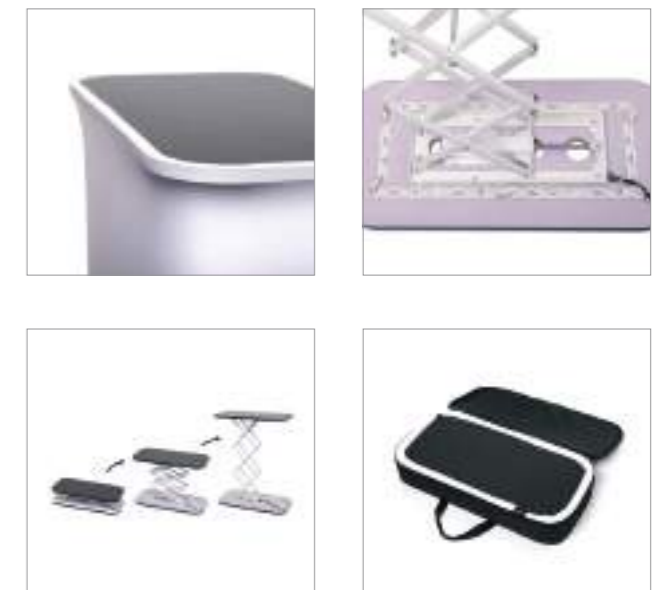



## BRIGHTBOX COUNTER

- IT**
- Connettori elettrici interni al telaio per una facile installazione senza cavi
  - Telaio stabile da 100 cm
  - Lati magnetici collegabili per unire molteplici Banchetti Brightbox
- ES**
- Conectores eléctricos en el interior del marco para fácil instalación sin cableado
  - Marco estable de 100 cm
  - Laterales con imán enlazables para poder colocar varios Brightbox con mostrador juntos
- FR**
- Connecteurs électriques intégrés dans le cadre pour une installation facile sans câbles
  - Cadre stable de 100 cm
  - Côtés magnétiques pouvant être interconnectés pour relier plusieurs comptoirs Brightbox entre eux

Art. nr.	W	H	D	KG
CBBOX-TTB	100	103	40	11

- Including Padded Carry Bag
- 6500 K colour temperature and Edge lit 24V LED Lights
- Optional: Block-Out for Backside (see p. 263)
- Perfect to combine with Brightbox Pro Flex, Single, Double and XL See chapter 3. Illuminated Displays (p. 55, 56 and 60)



## BRIGHTBOX COUNTER FOLD&GO



- IT**
- Banchetto illuminato a LED
  - Allestimento semplice mediante srotolamento
  - Facile fissaggio e sostituzione della stampa su tessuto (SEG)
- ES**
- Mostrador iluminado con LED
  - Se despliega sin esfuerzo
  - Fácil fijación y reemplazo de la impresión de tela (SEG)
- FR**
- Mise en place sans effort par dépliage
  - Comptoir lumineux avec LED
  - Fixation et remplacement faciles des visuels en tissu (SEG)



Art. nr.	Dimensions (cm)			
	W	H	D	KG
CBBOXFOLD-TTB	100	102,5	40	9

- Including Padded Carry Bag
- 6500 K colour temperature and Edge lit 24V LED Lights
- 85 mm thick frame
- For single-sided and double-sided use
- Perfect to combine with Brightbox Pro Flex and Fold&Go See chapter 3. Illuminated Displays (p. 57)
- Optional: Block-Out for Backside (see p. 263)



## FLEXFRAME COUNTER

- IT**
- Sistema modulare facile e senza attrezzi
  - Struttura resistente in alluminio con elegante piano d'appoggio nero
  - Ripiano interno incluso
- ES**
- Sistema modular fácil y sin herramientas
  - Estructura de aluminio resistente con elegante encimera negra
  - Incluye estante en el interior
- FR**
- Un système modulaire simple et sans outil
  - Structure en aluminium solide avec un élégant plateau noir
  - Étagère intérieure comprise



Art. nr.	Dimensions (cm)			
	W	H	D	KG
FFCTTB	100,2	103,7	34,5	11,5
FFCBLTTB	100,2	103,7	34,5	11,5

- Including Padded Carry Bag
- Create your full stand with the FlexFrame range
- Make a vivid impression with SEG fabric graphic
- Perfect to combine with FlexFrame Wall  
See chapter 18. Walls (p. 282)





## COUNTER IMPRESS

- IT**
- Telaio in alluminio che sostiene Grafiche di Bordi in Silicone
  - Attrezzabile con tende a LED per un effetto retroilluminato accattivante
  - Un sistema adatto con o senza tende a LED

- ES**
- Estructura de aluminio que mantiene los gráficos con bordes de silicona
  - Equipable con cortinas LED para un llamativo efecto retroiluminado
  - Un sistema adecuado con o sin cortinas LED

- FR**
- Cadre en aluminium maintenant des Silicone Edge Graphics
  - Peut être équipé de rideaux LED pour un effet rétroéclairé accrocheur
  - Système adapté avec ou sans rideaux à LED



Art. nr.	Dimensions (cm)			
	W	H	D	KG
CIMTTB	106	104	40	17
CIMTTB-LED	106	104	40	20

- Graphic available
- Optional: Black-Out Set (3 pcs) for LED option (see p. 263)
- Optional: Black Graphic Backside with zipper to close the back of the counter (see p. 263)
- Perfect to combine with Pop-Up Impress and other fabric walls. See chapter 18. Walls (p. 272)



## COUNTER FABRIC

- IT**
- Velcro resistente per attaccare le grafiche in modo facile e sicuro
  - Telaio pieghevole in alluminio, facile da riporre quando non viene utilizzato
  - Facile fissaggio e sostituzione della grafica in tessuto mediante velcro
- ES**
- Velcro resistente para una instalación de impresión fácil y segura
  - Estructura de aluminio plegable, fácil de guardar cuando no está en uso
  - Fácil cambio de impresión
- FR**
- Velcro robuste pour une fixation facile et sûre de l'impression
  - Cadre en aluminium pliable, facile à ranger lorsqu'il n'est pas utilisé
  - Visuel en tissu facilement interchangeable

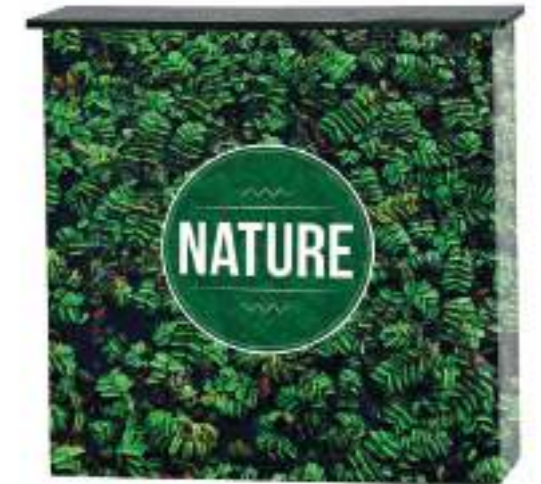

Art. nr.	☒	Dimensions (cm)			
		W	H	D	KG
CFTTB	●	106	102	40	18
CFTTW	●	106	102	40	18
CFTTS	○	106	102	40	18
CFTTWH	○	106	102	40	18

- Graphic available
- Perfect to combine with Pop-Up Fabric (Premium) and other fabric walls. See chapter 18. Walls (p. 275)



## COUNTER MAGNETIC

- IT**
- Telaio in alluminio stabile e robusto
  - Ripiano in legno incluso
  - Perfetto combinato con il Pop-Up Magnetico
- ES**
- Estructura de aluminio estable y robusto
  - Estante de madera incluido
  - Perfecto en combinación con el Pop-Up Magnetic
- FR**
- Cadre en aluminium stable et robuste
  - Etagère en bois incluse
  - Parfait lorsqu'il est combiné avec le Pop-Up Magnetic



now available with graphic →

Art. nr.	☒	Dimensions (cm)			
		W	H	D	KG
CMTTB	●	126	97	44	17
CMTTLO	●	126	97	44	17

- Optional: Extra Kit for New Visuals (see p. 262)
- Perfect to combine with Pop-Up Magnetic. See chapter 18. Walls (p. 276)



**COUNTER PROFESSIONAL ORIGINAL M**

NEW: ECO VERSION

BESTSELLER

- IT**
- Estremamente stabile grazie alla forma curva
  - Facile e veloce da assemblare
  - Ripiano in plastica opzionale
- ES**
- Extremadamente estable debido a su forma curva
  - Rápido y fácil de montar
  - Estante de plástico opcional
- FR**
- Extrêmement stable grâce à sa forme incurvée
  - Facile et rapide à assembler
  - Tablette en plastique en option

now available with graphic →



Art. nr.	Dimensions (cm)	W	H	D	KG
CPOMTTB	●	91	93	48	30
CPOMTTB-ECO	●	91	93	48	30
CPOMTTW	●	91	93	48	30
CPOMTTS	○	91	93	48	30
CPOMTTWH	○	91	93	48	30

- Optional: Plastic Shelf Round (see p. 262)
- Perfect to combine with Pop-Up Magnetic. See chapter 18. Walls (p. 276)

**COUNTER EASY OVAL**

- IT**
- Un design snello in una forma ovale
  - Borsa inclusa per un facile trasporto
  - Promozione senza grinze grazie al tessuto elastico con sistema SEG (Silicone Edge Graphic)
- ES**
- Diseño fino de forma ovalada
  - Incluye bolsa de transporte para fácil traslado
  - Promoción en tela sin arrugas gracias al borde de silicona (SEG)
- FR**
- Design mince de forme ovale
  - Sac de transport inclus pour faciliter le transport
  - Promotion infroissable grâce au tissu extensible Silicone Edge Graphic (SEG)



Art. nr.	Dimensions (cm)	W	H	D	KG
CEOTTB		59,5	101	39,5	6

- Graphic available
- Perfect to combine with Zipper-Walls. See chapter 18. Walls (p. 278)

**COUNTER PROFESSIONAL ORIGINAL L**

- IT**
- Estremamente stabile grazie alla forma curva
  - Molto spazio per la presentazione e lo stoccaggio
  - Ripiano in legno opzionale
- ES**
- Extremadamente estable debido a su forma curva
  - Mucho espacio para presentación y almacenamiento
  - Estante de madera opcional
- FR**
- Extrêmement stable en raison de sa forme incurvée
  - Beaucoup d'espace pour la présentation et le stockage
  - Tablette en bois en option

now available with graphic →



Art. nr.	Dimensions (cm)	W	H	D	KG
CPOLTTB	●	120	93	48	15*

\* In 2 boxes of 12 and 3 KG

- Optional: Wooden Shelf (see p. 264)
- Perfect to combine with Pop-Up Magnetic. See chapter 18. Walls (p. 276)



COUNTER PROFESSIONAL SQUARE

- IT**
  - Estremamente stabile
  - Spazio pratico per la presentazione e lo stoccaggio
  - Ripiano in plastica opzionale
- ES**
  - Muy estable
  - Práctico espacio de presentación y almacenamiento
  - Estante de plástico opcional
- FR**
  - Extrêmement stable
  - Espace pratique pour la présentation et le rangement
  - Tablette en plastique en option

now available with graphic →



Art. nr. Dimensions (cm)

	W	H	D	KG
CPSTTB	100	93	40	31,5

Optional: Plastic Shelf Square (see p. 262)

COUNTER PROMOTIONAL

- IT**
  - Completamente adesivo e un espositore a 2 m di altezza
  - Leggero e stabile
  - Ideale per campagne promozionali o dimostrazioni di prodotti
- ES**
  - Totalmente pegable y con 2 metros de altura
  - Ligero y estable
  - Ideal para usar en campañas promocionales o demostraciones de productos
- FR**
  - Entièrement autocollant avec un display à 2 m de hauteur
  - Léger et stable
  - Idéal pour les campagnes promotionnelles ou les démonstrations de produits

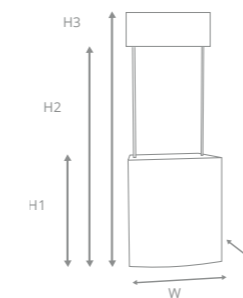

Art. nr. Dimensions (cm)

	W	H 1	H 2	H 3	D	KG
CPPROM	82	90	185	215	47	11



COUNTER PROFESSIONAL ROUND

- IT**
  - Alla moda, elegante e dalla forma giocosa
  - Assemblaggio rapido e semplice
  - Grafica a 360°
- ES**
  - Elegante, con estilo y una forma original
  - Fácil y rápido de montar
  - Impresión de 360°
- FR**
  - Forme élégante, élégante et ludique
  - Assemblage facile et rapide
  - Impression à 360°

now available with graphic →



Art. nr. Dimensions (cm)

	W	H	KG
CPRTTB	45	93	16

FLEX COUNTER

- IT**
  - Telaio in alluminio completamente ripiegabile
  - Alla moda, elegante e dalla forma giocosa
  - Facile e veloce da assemblare
- ES**
  - Estructura de aluminio completamente plegable
  - Elegante, con estilo y una forma divertida
  - Rápido y fácil de montar
- FR**
  - Cadre en aluminium entièrement pliable
  - Forme élégante, élégante et ludique
  - Assemblage rapide et facile

now available with graphic →



Art. nr. Dimensions (cm)

	Ø	H	KG
FLC	58	106	17

Optional: 8 extra PET panels for New Visuals (see p. 262)  
 Perfect to combine with Flex Tower. See chapter 3. Illuminated Displays (p. 54)

**PERSONALISED HIPS BOARD GRAPHICS**

Accessory for Flex Tower and Flex Counter



- IT** • Set di 8 pannelli stampati, PVC free
- ES** • Juego de 8 gráficos impresos en tablero sin PVC
- FR** • Ensemble de 8 visuels imprimés sur panneaux sans PVC

Art. nr. FLP-SETPRINT-HW1

**EXTRA KIT FOR NEW VISUALS**

Accessory for Counter Magnetic



- IT** • Nastro magnetico extra per nuove immagini Banchetto Magnetico
- ES** • Cinta magnética adicional para nuevos visuales Counter Magnetic
- FR** • Bande magnétique supplémentaire pour les nouveaux visuels Counter Magnetic

Art. nr. CMK1

**PLASTIC SHELF ROUND**

Accessory for Counter Professional Original M



- IT** • Ripiano in Plastica per Banchetto Professionale M
- ES** • Estante de plástico para Counter Professional M
- FR** • Étagère en plastique pour comptoir professionnel M

Art. nr. CPOMSHELF

**BLOCK-OUT BRIGHTBOX**

Accessory for Brightbox Counter and Brightbox Counter Fold&Go



- IT** • Pellicola Block-Out senza interruzioni per impedire alla luce di uscire
- ES** • Película opaca sin costuras para evitar que salga la luz
- FR** • Film de blocage sans couture, pour empêcher la lumière de sortir

Art. nr. CBBOX-BO

**BLOCK-OUT SET (3 PCS)**

Accessory for Counter Impress



- IT** • Pellicola Block-Out senza interruzioni per impedire alla luce di uscire
- ES** • Película opaca sin costuras para evitar que salga la luz
- FR** • Film de blocage sans couture, pour empêcher la lumière de sortir

Art. nr. CIM-BO

⊕ For sides and bottom

**BLACK GRAPHIC BACKSIDE**

Accessory for Counter Impress



- IT** • Retro con stampa nera e chiusura a cerniera
- ES** • Película opaca sin costuras para evitar que salga la luz
- FR** • Film de blocage sans couture, pour empêcher la lumière de sortir

Art. nr. CIM-BPZ

Pop-Up Impress Straight (p. 272/ch. 18), Pop-Up Impress Curved (p. 273/ch. 18) and Counter Impress (p. 256/ch. 17)

**WOODEN SHELF**

Accessory for Counter Professional Original L



- IT** • Ripiano in legno per Banchetto Professionale L
- ES** • Estantería de madera para Counter Professional L
- FR** • Étagère en bois pour comptoir professionnel L

Art. nr. CPOLSHELF

**PLASTIC SHELF SQUARE**

Accessory for Counter Professional Square



- IT** • Ripiano in Plastica per Banchetto Professionale Square
- ES** • Estante de plástico para Counter Professional Square
- FR** • Étagère en plastique pour comptoir professionnel carré

Art. nr. CPSSHELF

- 8 pannelli in PET extra per nuove immagini
- 8 paneles de PET adicionales para nuevas impresiones
- 8 panneaux PET supplémentaires pour nouveaux visuels



NEW: BLACK AND WHITE COLOUR

request a free graphic visualisation



## TABLE COVER STANDING ROUND

- EN**
  - Personalised Table Cover for round standing table of 80 cm diameter
  - Branding or custom designs in any colour possible
  - Wrinkle-free double stretch fabric for professional finish
- DE**
  - Personalisierte Tischhülle für runde Stehtische mit 80 cm Durchmesser
  - Branding oder individuelle Designs in jeder Farbe möglich
  - Knitterfreies doppeltes Stretchgewebe für ein professionelles Finish
- NL**
  - Gepersonaliseerde Statafelrok voor ronde statafel 80 cm Ø
  - Branding of designs in elke kleur mogelijk
  - Kreukvrije dubbele stretchstof voor een professionele afwerking



Art. nr.	Table size (cm)	Dimensions (cm)			
		W	H	D	KG
TCSR80	80 x 110	80	109,5	480	0,7
TCSR80BLK	80 x 110	80	109,5	480	0,7
TCSR80WH	80 x 110	80	109,5	480	0,7

Also available in standard black and white colour



## TABLE COVER ECONOMY AND ROYAL ECONOMY

- EN**
  - Open-back design that provides legroom
  - Easy accessible out-of-sight storage space
  - Machine-washable and wrinkle-resistant
- DE**
  - Design mit offener Rückseite, die Beinfreiheit bietet
  - Leicht zugänglich sichtgeschützter Stauraum
  - Waschmaschinenfest und Knitterschutz
- NL**
  - Open-back design voor beenruimte
  - Makkelijk toegankelijke opbergruimte buiten zicht
  - Wasmachine geschikt en kreukvrij



Art. nr.	Table size (inch)	Table size (cm)	Dimensions (cm)		
			W	H	KG
<b>Table Cover Economy</b>					
TCES265-155GSUB	57,1" x 26,8" x 28"	145 x 68 x 74	265	155	0,7
TCES325-170GSUB	69,7" x 29,92" x 28"	177 x 76 x 74	325	170	0,8
TCES387-170GSUB	94,5" x 29,9" x 28"	387 x 76 x 74	387	170	0,9
<b>Table Cover Royal Economy</b>					
TCES72-30-28GSUB	72" x 30" x 28"	183 x 76 x 74	325	170	0,9
TCES96-30-28GSUB	96" x 30" x 28"	244 x 76 x 74	386	170	1,1

Suitable for logo printing and full-colour printing



## BEER TABLE COVER SET

- EN**
  - Set of fabric table cover and two bench covers for standard beer tables
  - Poly Poplin 100% PES
  - B1 fire rated
- DE**
  - Set aus Stofftischbezug und zwei gepolsterten Bankbezügen für standard Biertische
  - Poly Poplin 100% PES
  - B1 Feuerfest
- NL**
  - Set van stoffen tafelhoezen en twee bankhoezen voor standaard biertafels
  - Polypopeline 100% PES
  - B1 brandwerend



Art. nr.	Table size (cm)	Bench size (cm)	Dimensions (cm)			
			W	H	D	KG
<b>Complete Set</b>						
BSTBC180	50 x 180	25 x 180				
BSTBC200	50 x 200	25 x 200				
<b>Table Cover</b>						
BSTC180	50 x 180		182	12	52	0,3
BSTC200	50 x 200		202	12	52	0,3
<b>Bench covers</b>						
BSBC180		25 x 180	182	12	27	0,2
BSBC200		25 x 200	202	12	27	0,2

Table and bench are not included



# 18. WALLS

Pareti  
Paneles Promocionales  
Murs

Leave an everlasting impression with one of the various walls. Pop-Ups and Zipper-Walls are durable, portable and decorative display systems for branding, promotions and a more impactful presentation. Set up and tear down in just a few minutes. Convenient transport cases keep you well organised and ready for the next event. The ideal solution for promotions, product presentations, trade shows and events.

- **QUICK AND EASY TO ASSEMBLE**
- **GRAPHIC AVAILABLE TO CUSTOMISE YOUR WALL**
- **VARIOUS LIGHT OPTIONS TO PUT YOURSELF IN THE SPOTLIGHT**



## INDEX

18.1 Lightboxes <i>Cassonetti luminosi</i> <i>Cajas de luz</i> <i>Caissons lumineux</i>	<b>268</b>
18.2 Pop-Ups <i>Pop-ups</i> <i>Pop-Ups</i> <i>Stands Parapluie</i>	<b>272</b>
18.3 Zipper-Walls <i>Zipper-Walls</i> <i>Estructuras Tubulares</i> <i>Zipper-Wall</i> <i>Structures Tubulaires</i> <i>Zipper-Wall</i>	<b>278</b>
18.4 Other Walls <i>Altre pareti</i> <i>Otras Paneles</i> <i>Autres Murs</i>	<b>282</b>



### ✓ GOOD POP-UP FABRIC

- Easy attachment and replacement of fabric graphic with Velcro
- Tool-free installation in less than 5 minutes
- Choose a stable mobile trolley case or a soft bag



### 👍 BETTER ZIPPER-WALL STRAIGHT BASIC

- Classic 32 mm frame for a great impression
- Easy and quick to assemble thanks to tool-free assembly
- Produced in our production centre in the Czech Republic



### 🏆 BEST POP-UP IMPRESS CURVED

- White curved aluminium frame that holds Silicone Edge Graphics
- Smooth curved back wall
- Equipable with LED-curtains for an eye-catching backlit effect

NEW

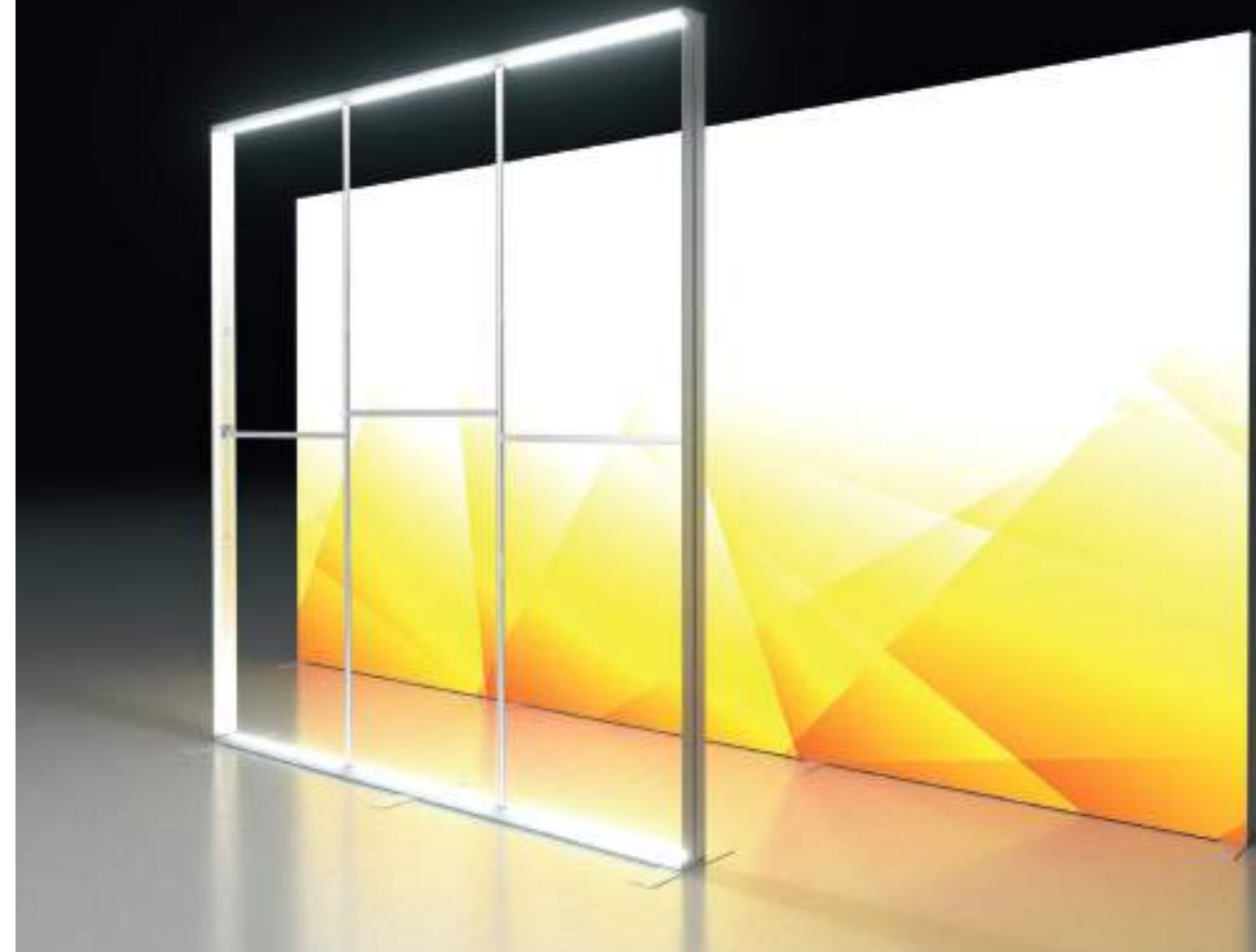

## BRIGHTBOX PRO FLEX WALL

IT • ???  
• ???  
• ???

ES • ???  
• ???  
• ???

FR • ???  
• ???  
• ???



Art. nr.	DIN/Size	Dimensions (cm)			
		W	H	D	KG
BBOXPFD100-300	100 x 300	100	301	45	?
BBOXPFD200-300	200 x 300	200	301	45	?
BBOXPFD300-300	300 x 300	300	301	45	?
BBOXPFD600-300	600 x 300	600	301	45	?

- Great addition to the Brightbox Family
- Perfect to combine with Brightbox Counter.  
See ch. 17 Counters and Table Covers (p. 252)



coming soon

BRIGHTBOX PRO FLEX ROOF



BRIGHTBOX PRO FLEX STORAGE



## BRIGHTBOX XL

- IT**
- Perfetto per esposizioni promozionali a breve termine
  - Montaggio e sostituzione grafiche in tessuto semplici (SEG)
  - Alternativa economica a Pop-Up Impress
- ES**
- Perfecto para promociones cortas durante las ferias
  - Fácil colocación y cambio de gráfica de tela (SEG)
  - Una alternativa asequible para Pop-Up Impress
- FR**
- Parfait pour les promotions à court terme lors des expositions
  - Fixation et remplacement faciles des visuels en tissu (SEG)
  - Une alternative économique pour Pop-Up Impress



Art. nr.	DIN/Size	Dimensions (cm)			
		W	H	D	KG
BBOXXL300-240	300 x 240	242	300,3	41,9	21,4

- Great addition to the Brightbox Family
- Perfect to combine with Brightbox Counter. See ch. 17 Counters and Table Covers (p. 252)



### BRIGHTBOX SINGLE

See 3. Illuminated Displays page 55

### BRIGHTBOX DOUBLE

See 3. Illuminated Displays page 56

### BRIGHTBOX FOLD&GO

See 3. Illuminated Displays page 57

### BRIGHTBOX COUNTER

See 17. Counters and Table Covers page 252

### BRIGHTBOX COUNTER FOLD&GO

See 17. Counters and Table Covers page 253



BESTSELLER



## POP-UP IMPRESS STRAIGHT

- IT**
- Il sistema Pop-Up per grafiche SEG con bordo in silicone più resistente sul mercato
  - Barre facilmente agganciabili con doppie scanalature profonde 14 mm
  - Tutti i sistemi sono adatti all'utilizzo con o senza tendine a LED
- ES**
- El sistema Pop-Up más resistente del mercado
  - Barras fáciles de colocar con ranuras dobles de 14 mm de profundidad
  - Todos los sistemas son adecuados para usar con o sin cortinas LED
- FR**
- Le système SEG Pop-Up le plus solide et le plus évolué du marché
  - Barres faciles à fixer avec rainures doubles de 14 mm de profondeur
  - Tous les systèmes sont adaptés pour une utilisation avec ou sans rideaux LED

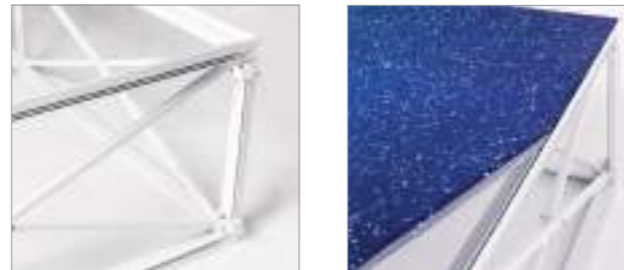

Art. nr.		DIN/Size	Dimensions (cm)				KG	
Without LED	With LED & Bars		W	H	D			
IMPR23S	IMPR23S-LEDPACK	2 x 3	151	224	36	13,6	28,4	
IMPR33S	IMPR33S-LEDPACK	3 x 3	224	224	36	16	34,6	
IMPR43S	IMPR43S-LEDPACK	4 x 3	298	224	36	18	41,6	
IMPR53S	IMPR53S-LEDPACK	5 x 3	371	224	36	21,3	50,3	
IMPR63S	IMPR63S-LEDPACK	6 x 3	444	224	36	23,2	56,2	
IMPR44S	IMPR44S-LEDPACK	4 x 4	298	298	36	21,3	43,7	
IMPR54S	IMPR54S-LEDPACK	5 x 4	371	298	36	24,8	52,5	

- Graphic available in standard and backlit graphic material
- Optional: Connectors, LED Light Curtains, LED Lighting, Extra Bars for Backside, Block-Out Film Backside and Feet (see p. 273 and 274)
- Perfect to combine with Counter Impress. See chapter 17. Counters and Table Covers (p. 256)



## POP-UP IMPRESS CURVED

- IT**
- Telaio in alluminio curvo che sostiene Grafiche di Bordi in Silicone
  - Fondo liscio e curvo
  - Attrezzabile con tende a LED per un effetto retroilluminato accattivante
- ES**
- Marco de aluminio curvo blanco que mantiene los gráficos con borde de silicona
  - Pared trasera lisa y curvada
  - Equipable con cortinas LED para un llamativo efecto retroiluminado
- FR**
- Cadre en aluminium blanc incurvé qui supporte des Silicone Edge Graphics
  - Paroi arrière lisse courbée
  - Peut être équipé avec des rideaux LED pour un effet rétroéclairé accrocheur



Art. nr.		DIN/Size	Dimensions (cm)				KG	
Without LED	With LED & Bars		W	H	D			
IMPR33C	IMPR33C-LEDPACK	4 x 3	233	224	57	16	34,6	

- Graphic available in standard and backlit graphic material
- Optional: Connectors, LED Light Curtains, LED Lighting, Extra Bars for Backside, Block-Out Film Backside and Feet (see p. 273 and 274)
- Perfect to combine with Counter Impress. See chapter 17. Counters and Table Covers (p. 256)



## CONNECTOR STRAIGHT SET

Accessory for Pop-Up Impress Straight and Pop-Up Impress Curved



- IT**
- Unione di due pareti in linea retta
- ES**
- Une dos Pop Ups entre sí en línea
- FR**
- Relie deux murs en ligne droite

Art. nr. IMPR-SC

## CONNECTOR 90 DEGREES SET

Accessory for Pop-Up Impress Straight



- IT**
- Unione di due pareti con un'angolazione a 90 gradi
- ES**
- Une dos pop-ups en un ángulo de 90 grados
- FR**
- Relie deux murs formant un angle de 90 degrés

Art. nr. IMPR-CC

### LED LIGHT SET FOR BACKLIT DISPLAY

Accessory for Pop-Up Impress Straight, Pop-Up Impress Curved



- IT** • Tende a LED retroilluminate separate compresa la Pellicola Black-Out per la parte inferiore, superiore e le due laterali
- ES** • Cortinas de luz LED retroiluminadas con un film de bloqueo en la parte posterior, superior y laterales
- FR** • Rideaux rétro éclairés pour LED séparées, avec film Blockout pour le bas, le haut et les côtés

<b>Art. nr.</b>	IMPR23S-LEDSET	IMPR54S-LEDSET
	IMPR33S-LEDSET	IMPR63S-LEDSET
	IMPR43S-LEDSET	
	IMPR44S-LEDSET	IMPR33C-LEDSET
	IMPR53S-LEDSET	

### EXTRA BARS FOR BACKSIDE

Accessory for Pop-Up Impress Straight, Pop-Up Impress Curved



- IT** • Barre extra per aggiungere grafiche senza interruzioni o Pellicola Black-Out sul telaio posteriore di PopUp Impress
- ES** • Barras adicionales para agregar diseños a la parte posterior del Pop-Up Impress
- FR** • Barres supplémentaires pour ajouter un graphique transparent ou un film block-out à l'arrière du cadre Pop-Up Impress

<b>Art. nr.</b>	IMPR23S-BARB	IMPR54S-BARB
	IMPR33S-BARB	IMPR63S-BARB
	IMPR43S-BARB	
	IMPR44S-BARB	IMPR33C-BARB
	IMPR53S-BARB	

### BLOCK-OUT FILM BACKSIDE

Accessory for Pop-Up Impress Straight, Pop-Up Impress Curved



- IT** • Pellicola Black-Out senza interruzioni per il telaio posteriore di Pop-Up Impress
- ES** • Película de bloqueo perfecta para el marco de Pop-Up Impress de la parte trasera
- FR** • Film de blocage transparent pour l'arrière du cadre Pop-Up Impress

<b>Art. nr.</b>	IMPR23S-BOB	IMPR54S-BOB
	IMPR33S-BOB	IMPR63S-BOB
	IMPR43S-BOB	
	IMPR44S-BOB	IMPR33C-BOB
	IMPR53S-BOB	

### POP-UP FABRIC

- IT** • Fissaggio e sostituzione facile della stampa su tessuto mediante velcro
- Installazione senza utensili in meno di 5 minuti
- Scegliete il trolley rigido o la borsa per il trasporto
- ES** • Fácil fijación y cambio de tela con velcro
- Instalación sin herramientas en menos de 5 minutos
- Elija entre maleta rígida o bolsa blanda
- FR** • Fixation et remplacement faciles de l'imprimé en tissu avec du Velcro
- Installation sans outil en moins de 5 minutes
- Choisissez un trolley ou un sac souple



Art. nr.	DIN/Size	Dimensions (cm)				KG
		W	H	D		
<b>Trolley Case</b>						
PUF23S	2 x 3	151	224	30		13,5
PUF33S	3 x 3	224	224	30		15,5
PUF43S	4 x 3	297	224	30		17,5
PUF53S	5 x 3	370	224	30		19,5
<b>Soft Bag</b>						
PUF33S-SB	3 x 3	224	224	30		9
PUF43S-SB	4 x 3	297	224	30		11

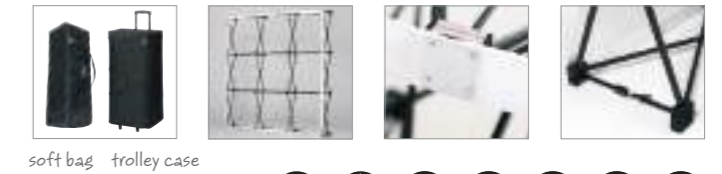

Perfect to combine with Counter Fabric. See chapter 17. Counters and Table Covers (p. 257)



### FEET

Accessory for Pop-Up Impress Straight, Pop-Up Impress Curved



- IT** • Piedini facilmente applicabili per una maggiore stabilità e un tocco elegante nella finitura
- ES** • Pies fáciles de conectar para mayor estabilidad y un toque final elegante
- FR** • Pieds faciles à fixer pour plus de stabilité et une finition élégante

<b>Art. nr.</b>	IMPR-FTWH	○
	IMPR-FTS	●
	IMPR-FTB	●

Recommended for more stability. Especially for frames of more than 6 levels wide

### POP-UP FABRIC PREMIUM STRAIGHT

- EN** • Profili in alluminio estremamente robusti e prestigiosi
- Fissaggio e sostituzione facile della stampa su tessuto mediante velcro
- Installazione senza utensili in meno di 5 minuti
- ES** • Perfiles de aluminio extremadamente resistentes y lujosos
- Fácil colocación y sustitución de la tela gracias al velcro
- Instalación sin herramientas en menos de 5 minutos
- FR** • Profils en aluminium extrêmement robustes et luxueux
- Fixation et remplacement faciles de l'imprimé en tissu avec du velcro
- Installation sans outil en moins de 5 minutes



Art. nr.	DIN/Size	Dimensions (cm)				
		W1	W2	H	D	KG
PUFP33S	3 x 3	220	256	220	36	16
PUFP43S	4 x 3	292	328	220	36	18
PUFP53S	5 x 3	363	399	220	36	21



Optional: LED Lighting (see p. 287)  
 The Pop-Up Fabric Premium Straight is fully equipped with Velcro for double-sided use  
 Perfect to combine with Counter Fabric. See chapter 17. Counters and Table Covers (p. 257)



## POP-UP MAGNETIC

- IT**
- Sistema a scatto pratico con magneti rinforzati da 12 mm
  - Custodia rigida convertibile in banchetto
  - Disponibile in versione curva e dritta
- ES**
- Sistema de clic práctico con imanes de potencia reforzados de 12 mm
  - Maleta convertible en mostrador
  - Disponible en versión curva y recta
- FR**
- Système de clic pratique avec de puissants aimants renforcés de 12 mm
  - Valise rigide convertible en comptoir
  - Disponible en version incurvée et droite

Art. Nr.	Art. Nr.	Dimensions (cm)			KG	KG
Hardcase	Soft Trolley	W	H	D	Hard Case	Soft Trolley
<b>Straight</b>						
PUM33S	PUM33S-ST	270	224	32	29	23
PUM43S	PUM43S-ST	343	224	32	31	27
PUM53S	PUM53S-ST	417	224	32	33	31
<b>Curved</b>						
PUM23C		192	224	51	27	-
PUM33C	PUM33C-ST	252	224	69	29	23
PUM43C	PUM43C-ST	301	224	100	31	27
PUM53C	PUM53C-ST	341	224	129	33	31



- Perfect to combine with Counter Magnetic. See chapter 17. Counters and Table Covers (p. 257)
- Optional: Table Top for Hardcase, Extra Kit for New Visuals, Bag for New or Backside Visuals, Extension Kit for Backside and LED lighting (see p. 277 and 287)

## POP-UP TOWER

- IT**
- Telaio in alluminio con cerniere e chiusura magnetica
  - Pannelli grafiche senza interruzioni a 360°
  - Compatta e facile da stoccare
- ES**
- Estructura de aluminio con bisagras y cierre magnético
  - Paneles gráficos sin costura de 360 °
  - Compacto y fácil de almacenar
- FR**
- Cadre en aluminium avec charnières et verrouillage magnétique
  - Panneaux graphiques sans couture à 360°
  - Compact et facile à ranger



Art. nr.	Dimensions (cm)		
	Ø	W	KG
PUTWR	64	225	16,5

- Included: Kit for new visuals, including plastic top strips (hangers) and magnetic tape (3-poles) with strong TESA self-adhesive
- Optional: Wall LED 50 (see p. 287)

## EXTRA KIT FOR NEW VISUALS

### Accessory for Pop-Up Magnetic



- IT**
- Nastro magnetico (3 pali) con autoadesivo resistente TESA
- ES**
- Cinta magnética (3 polos) con fuerte autoadhesivo TESA
- FR**
- Ruban magnétique (3 poteaux) avec adhésif TESA résistant

Art. nr.	PUM33CKIT	PUM33SKIT
	PUM43CKIT	PUM43SKIT
	PUM53CKIT	PUM53SKIT

## BAG FOR NEW OR BACKSIDE VISUALS

### Accessory for Pop-Up Magnetic



- IT**
- Borsa per tubo extra per proteggere le grafiche
- ES**
- Bolsillo extra para proteger la impresión
- FR**
- Sac tubulaire supplémentaire pour protéger le visuel

Art. nr.	PUM-BAGV7
	PUM-BAGV5B

## TABLE TOP

### Accessory for Pop-Up Magnetic Hard Case



- IT**
- Espositore da tavolo disponibile in 4 colori
- ES**
- Tablero disponible en 4 colores
- FR**
- Plateau de table disponible en 4 couleurs

Art. nr.	PUMTTB	●
	PUMTTW	●
	PUMTTS	○
	PUMTTWH	○

## EXTENSION KIT FOR BACKSIDE

### Accessory for Pop-Up Magnetic



- IT**
- Barra magnetica con nastro magnetico a 5 pali
- ES**
- Barra magnética con cinta magnética de 5 polos
- FR**
- Barre magnétique avec ruban magnétique à 5 pôles

Art. nr.	PUM33CE	PUM33SE
	PUM43CE	PUM43SE
	PUM53CE	PUM53SE

custom sizes available



## ZIPPER-WALL STRAIGHT BASIC

- IT**
  - Telaio classico da 32 mm per fare un'ottima impressione
  - Installazione facile e veloce grazie al montaggio senza utensili
  - Per utilizzo monofacciale o bifacciale
- ES**
  - Marco clásico de 32 mm para causar una gran impresión
  - Montaje fácil y rápido, ya que se trata de un sistema de montaje sin necesidad de herramientas
  - Para el uso a una o a doble cara
- FR**
  - Cadre classique de 32 mm pour une forte impression
  - Montage facile et rapide grâce à l'assemblage sans outils
  - Pour une utilisation simple ou double-face

Art. nr.	Dimensions (cm)			
	W	H	D	KG
ZWSE150-150	150	150	45	9,7
ZWSE200-150	200	150	45	10,1
ZWSE100-230	100	230	45	10
ZWSE150-230	150	230	45	10
ZWSE200-230	200	230	45	10,7
ZWSE250-230	250	230	45	12,2
ZWSE300-230	300	230	45	12,5
ZWSE400-230	400	230	45	15,7
ZWSE200-250	200	250	45	11,5
ZWSE200-300	200	300	45	12,3

- ⊕ Custom sizes and projects are available on request (European Production)
- Ⓛ Including Luxurious Soft Carry Bag
- ⊕ Optional: Upgrade with the Luxurious Padded Trolley Bag as accessory
- ⊕ Optional: Zipper-Wall Connector (see p. 279), LED Lighting and Clamp Tube (see p. 287)



## ZIPPER-WALL CONNECTOR

Accessory for Zipper-Wall Straight Basic



- IT** • Angolazione fino a 180 gradi
- ES** • Ángulo de hasta 180 grados
- FR** • Angle jusqu'à 180 degrés

Art. nr. ZW-CON



**ZIPPER-WALL STRAIGHT**

- IT**
  - Telaio tubolare in alluminio leggero da 34 mm
  - Per utilizzo monofacciale o bifacciale
  - Espositore con cerniera da parete Premium con trolley imbottito prestigioso
- ES**
  - Ligero marco de aluminio tubular de 34 mm
  - Para uso de una o dos caras
  - Premium Zipper-Wall con Lujosa Bolsa Acolchada con Ruedas
- FR**
  - Cadre tubulaire léger de 34 mm en aluminium
  - Pour une utilisation simple ou double-face
  - Zipper-Wall de qualité supérieure avec luxueux sac à roulette rembourré



Art. nr.	Dimensions (cm)			
	W	H	D	KG
ZWS150-230	150	230	45	10,7
ZWS200-230	200	230	45	11,3
ZWS250-230	250	230	45	12,9
ZWS300-230	300	230	45	13,3
ZWS400-230	400	230	45	16,6
ZWS500-230	500	230	45	17,8
ZWS600-230	600	230	45	18,6



- I** Including Luxurious Padded Trolley Bag
- +** Optional: LED Lighting and Clamp Tube (see p. 287)



**ZIPPER-WALL CURVED BASIC**

- IT**
  - Installazione facile e veloce grazie al montaggio senza utensili
  - Telaio tubolare in alluminio leggero da 32 mm
  - Borsa da trasporto morbida di lusso inclusa
- ES**
  - Montaje fácil y rápido sin necesidad de herramientas
  - Ligero marco de aluminio tubular de 32 mm
  - Maletín de transporte lujoso incluido
- FR**
  - Montage facile et rapide grâce à l'assemblage sans outils
  - Cadre tubulaire léger de 32 mm en aluminium
  - Inclus un luxueux sac de transport souple



Art. nr.	Dimensions (cm)			
	W	H	D	KG
ZWCE300-230	300	230	60	10,7
ZWCE400-230	400	230	60	11,1
ZWCE500-230	500	230	60	11,6



- I** Including Luxurious Soft Carry Bag
- +** Optional: Upgrade with the Luxurious Padded Trolley Bag as accessory
- +** Optional: LED Lighting and Clamp Tube (see p. 287)



**ZIPPER-WALL CURVED**

**BESTSELLER**

- IT**
  - Telaio tubolare in alluminio leggero
  - Il più famoso Espositore con cerniera da parete con una curva regolare
  - Duratura e facile da usare
- ES**
  - Estructura ligera de aluminio tubular
  - La Zipper Wall más popular con una curva suave
  - Duradero y fácil de usar
- FR**
  - Cadre tubulaire léger en aluminium
  - Le Zipper-Wall le plus populaire avec une courbe douce
  - Durable et facile à utiliser



Art. nr.	Dimensions (cm)			
	W	H	D	KG
ZWC300-230	300	230	60	10,4
ZWC400-230	400	230	80	11,4
ZWC500-230	500	230	100	14



- I** Including Luxurious Padded Trolley Bag
- +** Optional: LED Lighting and Clamp Tube (see p. 287)





## FLEXFRAME WALL

- IT**
- Struttura robusta in alluminio color argento e nero
  - Sistema modulare facile e senza attrezzi
  - Create il vostro stand completo con la gamma FlexFrame
- ES**
- Estructura de aluminio resistente en plata y negro
  - Sistema modular fácil y sin herramientas
  - Crea tu stand completo con la gama FlexFrame
- FR**
- Cadre en aluminium solide en couleur argent et noir
  - Un système modulaire simple et sans outil
  - Composez un stand complet avec la gamme FlexFrame

extend or connect the frames

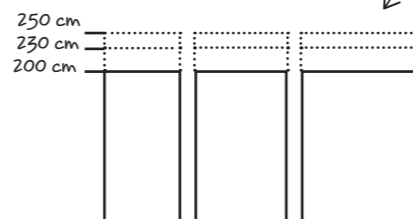

Art. nr.	DIN/Size	Dimensions (cm)			
		W	H	D	KG
FFW100x200	100 x 200	100	202	36	4,2
FFW100x230	100 x 230	100	33,5	4,2	0,4
FFW100x250	100 x 250	100	53,5	4,2	0,5
FFW120x200	120 x 200	120	202	36	4,3
FFW120x230	120 x 230	120	33,5	4,2	0,4
FFW120x250	120 x 250	120	53,5	4,2	0,6
FFW150x200	150 x 200	150	202	36	4,6
FFW150x230	150 x 230	150	33,5	4,2	0,4
FFW150x250	150 x 250	150	53,5	4,2	0,6
FFWBL100x200	100 x 200	100	202	36	4,2
FFW100x230BL	100 x 230	100	33,5	4,2	0,4
FFW100x250BL	100 x 250	100	53,5	4,2	0,5
FFWBL120x200	120 x 200	120	202	36	4,3
FFW120x230BL	120 x 230	120	33,5	4,2	0,4
FFW120x250BL	120 x 250	120	53,5	4,2	0,6
FFWBL150x200	150 x 200	150	202	36	4,6
FFW150x230BL	150 x 230	150	33,5	4,2	0,4
FFW150x250BL	150 x 250	150	53,5	4,2	0,6

- Make a vivid impression with SEG fabric graphic
- Including Padded Carry Bag
- Perfect to combine with FlexFrame Counter. See chapter 17. Counter and Table Covers (p. 254)
- Light up with Wall LED 50 or Wall LED 116 (p. 287)

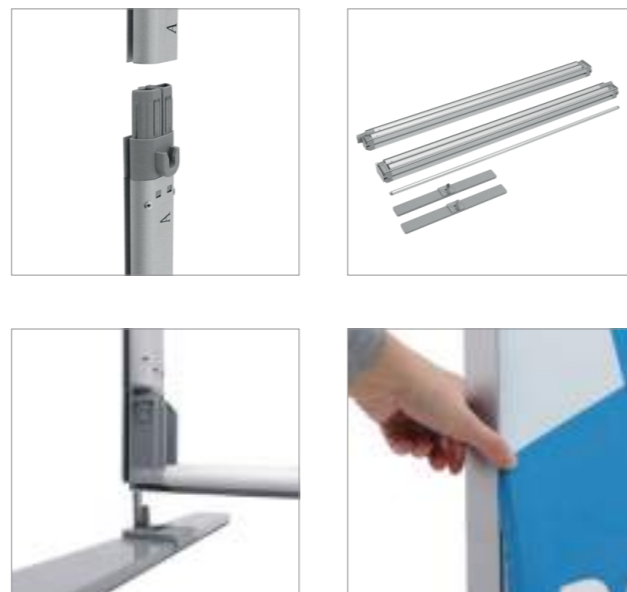

## FLEXFRAME ROOF

- IT**
- Installazione facile e senza attrezzi grazie ai connettori integrati
  - Create uno stile e un marchio extra nel vostro allestimento
  - Pezzo del FlexFrame con altezza fino a 250 cm
- ES**
- Montaje sencillo sin herramientas gracias a los conectores
  - Aporta estilo y refuerza tu imagen de marca
  - Parte del sistema FlexFrame, con opciones de altura de hasta 250 cm
- FR**
- Montage sencillo sin herramientas gracias a los conectores
  - Aporta estilo y refuerza tu imagen de marca
  - Parte del sistema FlexFrame, con opciones de altura de hasta 250 cm



Art. nr.	DIN/Size	Dimensions (cm)			
		W	H	D	KG
FFWRF100x200	100 x 200	100	200	4,4	2,6
FFWRF120x200	120 x 200	120	200	4,4	2,7
FFWRF150x200	150 x 200	150	200	4,4	3,0
FFWRF100x230	100 x 230	100	230	4,4	3,0
FFWRF120x230	120 x 230	120	230	4,4	3,1
FFWRF150x230	150 x 230	150	230	4,4	3,4
FFWRF100x250	100 x 250	100	250	4,4	3,2
FFWRF120x250	120 x 250	120	250	4,4	3,3
FFWRF150x250	150 x 250	150	250	4,4	3,5
FFWRFBL100x200	100 x 200	100	200	4,4	2,6
FFWRFBL120x200	120 x 200	120	200	4,4	2,7
FFWRFBL150x200	150 x 200	150	200	4,4	3,0
FFWRFBL100x230	100 x 230	100	230	4,4	3,0
FFWRFBL120x230	120 x 230	120	230	4,4	3,1
FFWRFBL150x230	150 x 230	150	230	4,4	3,4
FFWRFBL100x250	100 x 250	100	250	4,4	3,2
FFWRFBL120x250	120 x 250	120	250	4,4	3,3
FFWRFBL150x250	150 x 250	150	250	4,4	3,5

- Including Padded Carry Bag
- Adjustable height with Extension Set



## FLEXFRAME STORAGE SET

- IT**
- Barra di rinforzo d'angolo sulla parte superiore per garantire la stabilità
  - Serratura con codice integrata per proteggere gli oggetti personali
  - Pezzo del FlexFrame con altezza fino a 250 cm
- ES**
- Barra de refuerzo en la esquina superior para mayor estabilidad
  - Cerradura con código incorporada para proteger objetos personales
  - Parte del sistema FlexFrame, con opciones de altura de hasta 250 cm
- FR**
- Barre de renfort d'angle sur le dessus pour plus de stabilité
  - Serrure à code intégrée pour sécuriser les objets personnels
  - Fait partie du système FlexFrame, avec des options de hauteur jusqu'à 250 cm



Art. nr.	DIN/Size	Dimensions (cm)			
		W	H	D	KG
FFWSTOR100x200	100 x 200	102,2	203	106,4	6,3
FFWSTOR100x230	100 x 230	102,2	231	106,4	6,7
FFWSTOR100x250	100 x 250	102,2	251	106,4	6,9
FFWSTORBL100x200	100 x 200	102,2	203	106,4	6,3
FFWSTORBL100x230	100 x 230	102,2	231	106,4	6,7
FFWSTORBL100x250	100 x 250	102,2	251	106,4	6,9

- Including Padded Carry Bag
- Adjustable height with Extension Set



### FLEXFRAME TOP BANNER

- IT**
  - Design uniforme, da un lato all'altro, per una maggiore promozione del marchio
  - Perfetto da esporre sia su un solo lato che su due lati
  - Barre speciali per la stabilità all'interno
- ES**
  - Diseño sin juntas y a sangrado completo para una promoción de marca más visible
  - Perfecto para exposición a una o dos caras
  - Barras especiales internas para mayor estabilidad
- FR**
  - Design sans couture, bord à bord, pour une visibilité de marque optimale
  - Parfait pour une communication simple ou double face
  - Barres internes spéciales pour une stabilité renforcée



Art. nr.	DIN/Size	Dimensions (cm)			
		W	H	D	KG
FFWBAN300x30	300 x 30	304,5	30,2	4,2	3,3
FFWBANBL300x30	300 x 30	304,5	30,2	4,2	3,3

Including Padded Carry Bag



### FLEXFRAME CONNECTOR SET

Accessory for FlexFrame Wall



- IT**
  - Collega e modella la tua esposizione
- ES**
  - Conecta y da forma a tu display
- FR**
  - Assemblez et façonnez votre structure

Art. nr.	FFWCONSET	●
	FFWCONSETBL	●

### FLEXFRAME SINGLE FOOT

Accessory for FlexFrame Wall



- IT**
  - Piede sostitutivo – mezzo o intero – disponibile in nero o argento
- ES**
  - Pie de recambio (medio o completo) disponible en plata o negro
- FR**
  - Pied de remplacement – demi ou complet – disponible en gris silver ou en noir

Art. nr.	FFWFTDS	●
	FFWFTSS	●
	FFWFTDSBL	●
	FFWFTSSBL	●

### FLEXFRAME DOUBLE FOOT

Accessory for FlexFrame Wall



- IT**
  - Design doppio per collegare 2 strutture con un solo piede
- ES**
  - Diseño doble para montar 2 estructuras en un solo pie
- FR**
  - Conception double permettant de fixer deux cadres sur un seul pied

Art. nr.	FFWFTDST	●
	FFWFTSST	●
	FFWFTDSTBL	●
	FFWFTSSTBL	●

### TEXTILE FRAME TOWER

- IT**
  - Espositore a torre a quattro lati
  - Un'attrazione per gli spazi pubblici
  - Leggero ma robusto
- ES**
  - Expositor a cuatro caras
  - Espectacular para espacios públicos
  - De estructura ligera pero robusta
- FR**
  - Tour de présentation à quatre faces
  - Un coup de cœur dans les espaces publics
  - Léger, mais robuste

Art. nr.	DIN/Size	Dimensions (cm)			
		W	H	D	KG
TFRTOWER60x200	60 x 200	60	200,8	66	10,5
TFRTOWER85x200	85 x 200	85	200,8	91	10,9
TFRTOWER100x200	100 x 200	100	200,8	106	11,4

Other sizes and profile depths available on request



**FLEX WALL**

- IT**
  - Regolabile in altezza e ampiezza con pali telescopici
  - Sistema leggero, facile da trasportare e spostare
  - Una grande parete pubblicitaria adatta a ogni budget
- ES**
  - Su altura y su anchura son ajustables gracias a los postes telescópicos
  - Un sistema ligero, fácil de transportar y manipular
  - Una gran pared para sus anuncios perfecta para cualquier presupuesto
- FR**
  - Réglable en hauteur et en largeur grâce aux piquets télescopiques
  - Système léger, simple à transporter et à déplacer
  - Une super paroi de fond publicitaire, adaptée à tous les budgets



Art. nr.	Dimensions (cm)			
	W	H	D	KG
FLW-M	250	250	44	5
FLW-L	312	250,5	44	6,7



Graphic sizes M: Width 175 - 240 cm. Height 100 - 240 cm  
Graphic sizes L: Width 175 - 300 cm. Height 100 - 240 cm



**FENCE BANNER**

- IT**
  - Banner pubblicitario in tessuto adatto al fissaggio su muro, edifici e recinzioni
  - Impatto elevato e in varie misure
  - Grafica a sublimazione stabile con occhielli in plastica trasparente
- ES**
  - Banner de tela para anuncios apto para ser colgado en la pared, en la fachada de un edificio o en una valla
  - Gran impacto con varios tamaños
  - Estable gráfica impresa por sublimación con arandelas de plástico transparente
- FR**
  - Bannière publicitaire en tissu pour l'extérieur pouvant être fixée aux murs, aux bâtiments et aux clôtures
  - Impact élevé avec différentes tailles
  - Graphique stable avec impression par sublimation avec œillets en plastique transparent



Art. nr.	Dimensions (cm)			
	W	H	D	KG
FBG200-100	200	100	0,2	0,4



Including mounting strips  
Other sizes are available on request



**WALL LED 50**

Accessory for every Pop-Up and on several exhibitions stands



- IT** • Include connettori Telaio e Pop-Up
- ES** • Incluye los conectores del pop-up y la estructura
- FR** • Inclus clips pop-up et flex frame

Art. nr. WLED50B ●  
WLED50S ●  
WLED50WH ○

**Y-CABLE**

Accessory for WLED50



- IT** • Cavo a Y collega 2 WLED 50
- ES** • Cable-Y conecta 2 WLED 50
- FR** • Cable-Y permettant de connecter 2 WLED 50

Art. nr. WLEDY

**WALL LED 116**

Accessory for every Pop-Up and on several exhibitions stands



- IT** • Include connettori Telaio e Pop-Up
- ES** • Incluye los conectores del pop-up y la estructura
- FR** • Clips pop-up et flex frame inclus

Art. nr. Power plug backside  
WLED116B-BACK ●  
WLED116S-BACK ●

Power plug left & right side  
WLED116B-SIDE ●  
WLED116S-SIDE ●

**LUXURIOUS LIGHT BAG**

Accessory for WLED50 and WLED116



- IT** • Adatto ad alloggiare 3 luci
- ES** • Apto para almacenar 3 luces
- FR** • Convient pour stocker 3 lumières

Art. nr. L-BAG-M (WLED50)  
L-BAG-L (WLED116)

**WALL LIGHT CLAMP TUBE**

Accessory for every Zipper-Wall



- IT** • Collare per tubi adatto a tubi con Ø 30 - 34 mm
- ES** • Adecuado para tubos de Ø 30 - 34 mm
- FR** • Collier de serrage pour tubes d'un Ø de 30 à 34 mm

Art. nr. WLCTB ●  
WLCTS ●  
WLCTWH ○

**WALL LIGHT CLAMP WALL**

Accessory for exhibitions stands



- IT** • Collare da parete fino a un massimo di 53 mm
- ES** • Abrazadera para paredes de un máximo de 53 mm
- FR** • Fixation murale jusqu'à 53 mm max

Art. nr. WLCWB ●  
WLCWS ●  
WLCWWH ○

## 19. TENTS, UMBRELLAS AND SEATS

Gazebo, ombrelloni e sedie  
Carpas, parasoles y asientos  
Tentes, parasols et sièges

Draw attention, spark interest, claim the location, and advertise with impressive Tents and Umbrellas! Ideal for any outdoor event or promotion. Perfect for various settings, from trade shows to public centres, entrances, terraces at hospitality establishments such as restaurants and cafes, and beyond. Tents and Umbrellas both offer great opportunities for branding, in addition to providing shelter and shade. Easy to set up and in different sizes. Choose the design, setting and configuration you dream of!

- ✦ WEATHER RESISTIBLE SIGNAGE
- ✦ PORTABLE OUTDOOR PRODUCTS, SO YOU CAN EASILY MOVE THEM WHERE NEEDED
- ✦ GRAPHIC AVAILABLE TO CUSTOMISE YOUR OUTDOOR PRODUCT

### INDEX

19.1 Tents and Accessories **290**  
*Tende e accessori*  
*Carpas y Accesorios*  
*Tentes et Accessoires*

19.2 Umbrellas and Accessories **294**  
*Ombrelloni e accessori*  
*Parasoles y accesorios*  
*Parasols et accessoires*

19.3 Beach Chairs and Cubes **298**  
*Sedie a sdraio e cubi promozionali*  
*Sillas de playa y cubos*  
*Chillennes et cubes*



PATENTED

request  
a free graphic  
visualisation



## TENT ALU

- IT**
- Tubi esagonali in alluminio lucido da 40 mm
  - Piedini rotondi brevettati che facilitano lo spostamento della tenda
  - Tenda resistente in alluminio con borsa da trasporto a rotelle
- ES**
- Tubos lisos hexagonales de aluminio de 40 mm
  - Patas redondas y patentadas para facilitar la movilidad de la Carpa
  - Carpa de aluminio sólida viene con una bolsa transportadora con ruedas
- FR**
- Tubes hexagonaux en aluminium lisse de 40 mm
  - Pieds ronds brevetés qui facilitent le déplacement de la tente
  - Solide tente en aluminium avec sac de transport à roulettes



Art. nr.	Dimensions (cm)			
	W	H	D	KG
TA3	300	342	300	20
TA4,5	300	342	450	25
TA6	300	342	600	32

\*Set in 2 boxes

- 1 Including bag and stake kit
- 1 Canopy not standard included. Easily add your graphic to the order



### CANOPY

Accessory for Tent Alu



- IT** • Impermeabile grazie alla cucitura sigillata
- ES** • Resistente al agua gracias a su la costura cosida sellada
- FR** • Imperméable grâce à la couture cousue scellée

<b>Art. nr.</b> T3CAN-G	Full Colour 3x3 m
T4,5CAN-G	Full Colour 3x4,5 m
T6CAN-G	Full Colour 3x6 m
T3CAN-GWH	White 3x3 m
T4,5CAN-GWH	White 3x4,5 m
T6CAN-GWH	White 3x6 m

### FULL WALL

Accessory for Tent Alu



- IT** • Grafica in poliestere duratura con cinghie in velcro per fissare la grafica ai montanti del gazebo
- ES** • Gráfico de poliéster duradero con tiras de velcro para asegurar la impresión en las patas de la carpa
- FR** • Graphique en polyester durable avec bandes velcro pour fixer l'impression aux pieds de la tente

<b>Art. nr.</b> T3-GWI	Inside 3x3 m
T4,5-GWI	Inside 3x4,5 m
T6-GWI	Inside 3x6 m
T3-GWO	Outside 3x3 m
T4,5-GWO	Outside 3x4,5 m
T6-GWO	Outside 3x6 m
T3-GWDS	Double-Sided 3x3 m
T4,5-GWDS	Double-Sided 3x4,5 m
T6-GWDS	Double-Sided 3x6 m

### HALF WALL

Accessory for Tent Alu



- IT** • Grafica in poliestere duratura con cinghie in velcro per fissare la grafica ai montanti del gazebo
- ES** • Gráfico de poliéster duradero con tiras de velcro para asegurar la impresión en las patas de la carpa
- FR** • Graphique en polyester durable avec bandes velcro pour fixer l'impression aux pieds de la tente

<b>Art. nr.</b> T3-GHW	Single-Sided 3x3 m
T4,5-GHW	Single-Sided 3x4,5 m
T3-GHWDS	Double-Sided 3x3 m
T4,5-GHWDS	Double-Sided 3x4,5 m

### HALF WALL SUPPORT BAR

Accessory for Tent Alu



- IT** • Barra di supporto in acciaio e morsetti per grafica gazebo a mezza parete
- ES** • Barra de soporte de aluminio y abrazaderas para gráfico de carpa de media pared
- FR** • Barre de support en aluminium et pinces pour visuel de tente à demiparoi

<b>Art. nr.</b> TA3-HWB	Half Wall Support Bar 3x3 m
TA4,5-HWB	Half Wall Support Bar 3x4,5 m

### CONNECTOR

Accessory for Tent Alu



- IT** • Morsetti durevoli e resistenti alle intemperie che collegano due gazebo insieme
- ES** • Abrazaderas duraderas y resistentes a la intemperie que conectan dos carpas juntas
- FR** • Pincas solides et résistantes aux intempéries pour interconnecter deux tentes

**Art. nr.** TA-CON

### STEEL PLATE 5 KG

Accessory for Tent Alu



- IT** • Peso d'acciaio resistente per fissaggio ai montanti del gazebo
- ES** • Peso de acero resistente para sujetar a las patas de la carpa
- FR** • Poids en acier résistant pour la fixation aux pieds de la tente

**Art. nr.** TA-ST5

### STAKE KIT

Accessory for Tent Alu



- IT** • Set da 4 picchetti e 4 corde in poliestere per un fissaggio più sicuro del gazebo
- ES** • Juego de 4 estacas de tierra y 4 cuerdas de poliéster, para la fijación adicional de la carpa
- FR** • Jeu de 4 piquets de sol et de 4 cordes en polyester, pour une fixation plus sûre de la tente

**Art. nr.** TA-SK

### FLAG HOLDER SET

Accessory for Tent Alu



- IT** • Morsetti durevoli e resistenti alle intemperie che permettono alla bandiera di ruotare in base al vento
- Set di 2 supporti bandiera per un rotatore da 17 mm
- ES** • Abrazaderas duraderas y resistentes a la intemperie que permiten que la bandera gire con el viento
- Set de 2 portabanderas para rotador de 17 mm
- FR** • Solides pinces résistantes aux intempéries qui permettent au drapeau de tourner dans le vent
- Jeu de 2 porte-drapeaux pour rotateur de 17 mm

**Art. nr.** TAFH-17

ⓘ Connector for Beach Flag Budget Small and Medium. See chapter 16. Flags (p. 240 - 241)

### SAND BAG

Accessory for Tent Alu



- IT** • Morsetti durevoli e resistenti alle intemperie che collegano due gazebo insieme
- ES** • Perfecto para mejorar la estabilidad de las Carpas
- FR** • Parfait pour améliorer la stabilité des tentes

**Art. nr.** T-SB

### HEAVY DUTY STAKE KIT

Accessory for Tent Alu



- IT** • Perfetta per migliorare la stabilità dei Gazebo
- ES** • Juego de 4 estacas de tierra y 4 cuerdas de poliéster, para la fijación adicional de la carpa
- FR** • Jeu de 4 piquets de sol et de 4 cordes en polyester, pour une fixation plus sûre de la tente

**Art. nr.** T-SK-HD



## HORECA UMBRELLA ANTIQUE

- IT**
  - Struttura in legno con vernice di protezione e finiture laccate
  - Occhielli per il fissaggio della tettoia
  - Meccanismo a spinta semplice e manuale
- ES**
  - Marco de madera con barniz protector y lacado
  - Arandelas para sujetar el toldo
  - Mecanismo de empuje manual y fácil
- FR**
  - Cadre en bois avec vernis de protection et finition laquée
  - Œillets pour fixer le parasol
  - Mécanisme d'ouverture manuelle facile



Art. nr.	Dimensions (cm)				KG
	W	H	D		
SU300x300DB	300	300	300		15,6

Canopy not standard included. Easily add your graphic to the order

## HORECA UMBRELLA SLIDE

- IT**
  - Resiste a tutte le condizioni atmosferiche
  - Manovella facile da usare per aprire e chiudere il prodotto con semplicità
  - Palo in alluminio da 38 mm con stecche in alluminio da 25 mm
- ES**
  - Resiste todas las condiciones meteorológicas
  - Mango ergonómico para abrir y cerrar fácilmente
  - Mástil de aluminio de 38 mm con varillas de aluminio de 25 mm
- FR**
  - Résiste à toutes les conditions météorologiques
  - Poignée ergonomique pour ouverture et fermeture faciles
  - Mât en aluminium de 38 mm avec baleines de 25 mm



Art. nr.	Dimensions (cm)				KG
	W	H	D		
SURSLIDE200BL	200	200	200		2,5

Canopy not standard included. Easily add your graphic to the order



## HORECA UMBRELLA ANTIQUE BASE

Accessory for Horeca Umbrella Antique



- IT** • Base de hormigón con mezcla de piedra
- ES** • Base en béton avec mélange de pierre
- FR** • Base en calcestruzzi rivestita di pietra

Art. nr. SUBASE55

## HORECA UMBRELLA STEEL PLATE

Accessory for Horeca Umbrella Slide



- IT** • Base in acciaio robusta per un fissaggio sicuro all'Horeca Umbrella Slide
- ES** • Peso de acero resistente para una fijación segura del Parasol Horeca Slide
- FR** • Poids en acier robuste pour une fixation sécurisée au Parasol Horeca Slide

Art. nr. SUBASESTEEL17

## HORECA UMBRELLA WATER TANK

Accessory for Horeca Umbrella Slide



- IT** • La base con serbatoio d'acqua è l'opzione più robusta tra le nostre basi
- ES** • El tanque de agua es la opción más pesada entre nuestras bases
- FR** • Le réservoir d'eau est l'option la plus lourde parmi nos socles

Art. nr. SUBASETANK45

**BEACH CHAIR RELAX CLASSIC**

NEW

- IT**
  - Il classico della sedia da spiaggia a un prezzo accessibile
  - Legno di faggio di alta qualità con finitura liscia e levigata
  - Personalizzabile con stampa completa
- ES**
  - La clásica silla de playa a un precio asequible
  - Madera de haya de alta calidad con acabado lijado suave
  - Personalizable con impresión total
- FR**
  - La chaise longue classique à un prix abordable
  - Bois de hêtre de haute qualité avec une finition poncée lisse
  - Personnalisable avec une impression intégrale



Art. nr.	DIN/Size	Dimensions (cm)			
		W	H	D	KG
BCRCL		580	850	915	3,3
+ BCRCL-G	460 x 1420	-	-	-	0,2
+ BCRCL-GF	460 x 1420	-	-	-	0,2

**BEACH CHAIR RELAX BOLD**

NEW

- IT**
  - Telaio più spesso della gamma per una durata eccezionale
  - Finitura a olio protettiva per un look opaco e raffinato
  - Personalizzabile con stampa completa
- ES**
  - Estructura más gruesa de la gama para una durabilidad incomparable
  - Acabado protector con aceite para un aspecto mate refinado
  - Personalizable con impresión total
- FR**
  - Structure la plus épaisse de la gamme pour une durabilité maximale
  - Finition à l'huile protectrice pour un aspect mat raffiné
  - Personnalisable avec une impression intégrale



Art. nr.	DIN/Size	Dimensions (cm)			
		W	H	D	KG
BCRBBLB		580	1070	1000	5,4
+ BCRB-G	460 x 1520	-	-	-	0,2
+ BCRB-GF	460 x 1520	-	-	-	0,2

**BEACH CHAIR RELAX COMFORT**

NEW

- IT**
  - Pratici braccioli con portabicchieri integrato
  - Legno di faggio di alta qualità con finitura liscia e levigata
  - Personalizzabile con stampa completa
- ES**
  - Reposabrazos prácticos con portavasos integrado
  - Madera de haya de alta calidad con acabado lijado suave
  - Personalizable con impresión total
- FR**
  - Accoudoirs pratiques avec porte-gobelet intégré
  - Bois de hêtre de haute qualité avec une finition poncée lisse
  - Personnalisable avec une impression intégrale



Art. nr.	DIN/Size	Dimensions (cm)			
		W	H	D	KG
BCRCO		720	810	1115	4,4
+ BCRCO-G	460 x 1520	-	-	-	0,2
+ BCRCO-GF	460 x 1520	-	-	-	0,2

**BEACH CHAIR RELAX DUO**

NEW

- IT**
  - Classica sedia da spiaggia progettata per due persone
  - Pieghevole e resistente, supporta fino a 160 kg
  - Personalizzabile con stampa completa
- ES**
  - Silla de playa clásica diseñada para dos personas
  - Plegable y lo suficientemente resistente para soportar hasta 160 kg
  - Personalizable con impresión total
- FR**
  - Chaise longue classique conçue pour deux personnes
  - Pliable et suffisamment robuste pour supporter jusqu'à 160 kg
  - Personnalisable avec une impression intégrale



Art. nr.	DIN/Size	Dimensions (cm)			
		W	H	D	KG
BCRCD		1140	670	1250	8,5
+ BCRCD-G	1000 x 1560	-	-	-	0,4
+ BCRCD-GF	1000 x 1560	-	-	-	0,4

## CUBE SEAT CLASSIC

NEW

- IT**
- Cubo promozionale in schiuma (40x40x40 cm)
  - Consegnato in un unico pezzo, non necessita montaggio
  - Rivestimento in tessuto personalizzabile e facilmente intercambiabile
- ES**
- Cubo promocional de espuma (40x40x40 cm)
  - Entregado en una sola pieza, sin necesidad de montaje
  - Tela personalizada fácilmente intercambiable
- FR**
- Cube en mousse promotionnel (40x40x40 cm)
  - Livré en une seule pièce, sans besoin d'assemblage
  - Housse personnalisable facilement interchangeable



Art. nr.	DIN/Size	Dimensions (cm)			
		W	H	D	KG
CUBESC40		40	40	40	2,4
+ CUBE40G	40 x 40	41	41	41	0,2

⊕ Holds up to 120 kg

## CUBE SEAT FOLD

NEW

- IT**
- Cubo promozionale in cartone (40x40x40 cm)
  - Ecologico e riciclabile
  - Rivestimento in tessuto personalizzabile e facilmente intercambiabile
- ES**
- Cubo promocional de cartón (40x40x40 cm)
  - Ecológico y reciclable
  - Tela personalizada fácilmente intercambiable
- FR**
- Cube en carton promotionnel (40x40x40 cm)
  - Écologique et recyclable
  - Housse personnalisable facilement interchangeable



Art. nr.	DIN/Size	Dimensions (cm)			
		W	H	D	KG
CUBESF40		40	40	40	2,5
+ CUBE40G	40 x 40	41	41	41	0,2

⊕ Holds up to 120 kg

300 ⊕ Graphic available



# PRINT SERVICES

## when latex graphic?

- High resolution print technology
- Water based inks certified ECO 14142007
- Efficient printing times and great colour quality
- Quick production process with fast ink drying
- B1 fire rated materials (marked)
- Water resistant materials (marked)
- Allows outdoor use with most print media



Choose for ecological posters with the pure paper with the Premium Poster Paper. This print material is made from cellulose fibres derived from wood). Or go for a Roll-Banner promotion without any PVC! For both prints we use water-based, ECOLOGO® 2801 certified Latex inks.



With love for the world and environment you can choose for Eco Dye Sublimation graphics on recycled print material. Next to that, water-bases inks are being used. Wave your Beach Flag or promote your Zipper-Banner Slim in eco prints! For both prints we use water-based, ECO PASSPORT certified Dye Sublimation inks. All the same great quality, only with a little extra love for the environment.

## when uv flatbed graphic?

- Extra personalisation and branding possibilities
- Print on various rigid materials
- Excellent and vivid colours
- Industry leading print quality with Vanguard printer
- Max. printing area 250 x 125 cm
- Print on up to 100 mm thick material

read more about our printing techniques and materials online

### FILES WE WORK WITH

- ➕ **VECTOR:** PDF, EPS, AI
- ➕ **RASTER:** PDF, TIFF, JPG, PSD

## when dye sublimation graphic?

- For Polyester based fabric graphics
- Environmental friendly water based inks
- Ink sublimates into fabric fibres
- Direct print or transfer print
- Great printing and colour quality
- Quick production processes
- Most print materials are B1 rated (marked)
- Water resistant materials (marked)



Latex Graphics								
	PVC FREE Material Premium Poster Paper	PVC FREE Material Standard Multi Layer	PVC FREE Material Poster Backlit	Material Symbio Banner	PVC FREE Material Opaque Fabric	PVC FREE Material Polyester Greyback	Material Adhesive Foil	PVC FREE Material Solid Flex
<b>Products</b>								
Roll-Banners		•		•	•	•		
Poster Frames	•	•						
A-Boards	•	•						
LED Poster Frames			•					
Topcards, individual							•	
Stickers							•	
Counter Professional / Counter Magnetic								•
Lightbox (Arcuato)			•					
<b>Quality</b>								
Material	Semi Gloss Paper	PET/PP Hybrid film	Pet/PP film	PVC banner	Polyester fabric (PES)	Polyester Greyback (100% PES)	PVC Monometric foil	PET with silver block-out
Weight	135 g/m <sup>2</sup>	220g/m <sup>2</sup>	285 g/m <sup>2</sup>	510 g/m <sup>2</sup>	265 g/m <sup>2</sup>	270 g/m <sup>2</sup>	140 g/m <sup>2</sup>	415 g/m <sup>2</sup>
Max width in mm	1350	1250	1350	1500	•	1200	1000	1067
Weather resistant		•	•	•			•	•
B1 Certificate					• B2	•	•	•

Dye Sublimation Graphics												
	Material Flag (direct)	Material Wind Green	Material Silverback (direct)	Material Soft Knit	Material Soft Knit Eco	Material Starlight	Material Samba	Material Lumina	Material Poplin	Material Super Power Stretch	Material Vivid Tent	Material Soft Tent
<b>Products</b>												
Single-Sided Flags	•	•										
Double-Sided Flags			•									
Brightboxes (all types)						•	•	•				
Zipper-Walls (all types), Banner Stands				•								
Flex Wall				•					•			
Textile Frames				•				•				
Pop-Up Walls				•								
Impress No light				•								
Impress Backlit								•				
Counters with fabric				•								
FlexFrame				•								
Counter Easy Oval										•		
Table Throws										•		
Micro Flag	•		•									
Zipper-Banner Slim				•	•							
Tents											•	
Table Cover Standing Round										•		
Counter Bounce-Up								•				
Umbrellas												•
Cube Seats											•	
Beach Chairs												•
<b>Quality</b>												
Material	100% PES, knitted	100% Recycled Polyester (rPET), knitted	100% PES, knitted	100% PES, knitted	100% PES, knitted	100% PES, woven	100% PES, woven	100% PES, woven	100% PES, knitted	Polyester fabric (PES)	100% PCT Polyester	100% PCT Polyester
Weight	110 g/m <sup>2</sup>	110 g/m <sup>2</sup>	120 g/m <sup>2</sup>	230 g/m <sup>2</sup>	230 g/m <sup>2</sup>	180 g/m <sup>2</sup>	195 g/m <sup>2</sup>	190 g/m <sup>2</sup>	170 g/m <sup>2</sup>	280 g/m <sup>2</sup>	270 g/m <sup>2</sup>	190 g/m <sup>2</sup>
Max width	2600 mm	3200 mm	2600 mm	3200 mm	2500 mm	2500 mm	2600 mm	3000 mm	2500 mm	1500 mm	2500 mm	2600 mm
Weather resistant	•	•	•				•		•			•
Printed direct	•		•									
Printed transfer		•		•	•	•	•	•	•	•		•
Can be folded	•	•	•	•	•		•	•	•	•		•
B1 Certificate	•	•	•	•	•	•	•	•	•	•		•

Panel Graphics				
	Material FOREX®	PVC FREE Material HIPS	PVC FREE Material KAPA®	PVC FREE Material BOND
<b>Products</b>				
Indoor Wall Sign Basic	•		•	
Indoor Wall Sign Economy		•		
Indoor Wall Sign Compasso®	•			
Indoor Wall Sign with Wall Brackets				•
Outdoor Wall Sign				•
Overhead Banners			•	
Panel Base Steel				•
Interlocking Base			•	
Natura Easel			•	
Totem Panel+	•			
Menu Board Stick-On / A-Board Stick-On				•
Wall Sign Click				•
A-Board Grab&Grip				•
Flex Tower		•		
<b>Quality</b>				
Material	Foamed PVC	High Impact Polystyrene	Polyurethane foamed core	PE with 0.21 mm aluminum coating
Thickness	3 mm	1 mm	5 mm	3 mm
Max print size	2400 x 1200 mm	2000 x 1000 mm	2400 x 1200 mm	2550 x 1550 mm
Weather resistant	•			•
B1 Certificate				•
Single- / Double-Sided	Double-Sided	Double-Sided	Double-Sided	Double-Sided
Certifications			ISO 9001, 14002, 50001 / FSC	

**AMIS**

06 21 06 17 21

[commerciaux.amis@gmail.com](mailto:commerciaux.amis@gmail.com)

SARL AMIS / Quelque part en Provence...